

Alaris™ Syringe Pump (with Plus Software) MK4

Models: 8002MED01, 8002MED01-G, 8002TIG01, 8002TIG01-G
8003MED01, 8003MED01-G, 8003TIG01, 8003TIG01-G

Directions For Use
en

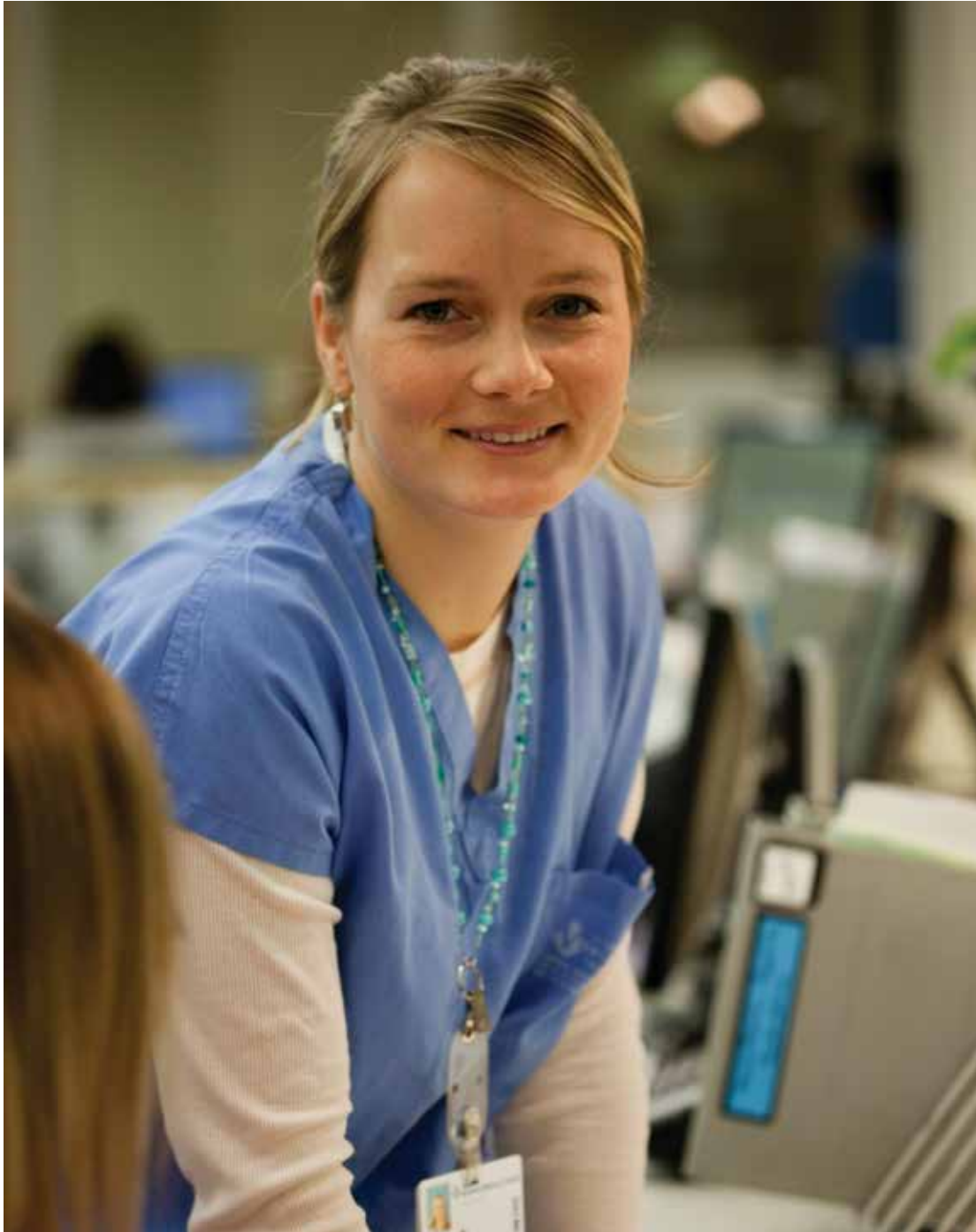

CE
0086

 CareFusion

Contents

	Page
Introduction	2
About This Manual	3
Creating a Data Set.....	4
Features of the Pump.....	5
Controls and Indicators	6
Symbol Definitions.....	7
Main Display Features	8
Operating Precautions	9
Getting Started	12
Securing the Syringe with Optional Lock box.....	14
Syringe Loading.....	15
Starting the Pump.....	18
Basic Features	20
Pressure Features	24
Alarms and Warnings.....	25
Configured Options	28
Specifications	33
Recognised Syringes	36
Associated Products.....	37
Compatible Extension Sets	38
Maintenance.....	40
Occlusion Pressure Limits	42
IrDA, RS232 and Nurse call Specification	44
Trumpet Curves and Start-up Curves	46
Products and Spare Parts	48
Service Contacts	49

Introduction

This Directions for use can be used with the following Mark 4 (MK4) pumps:-

- Alaris™ CC Guardrails™ Syringe Pump
- Alaris™ CC Syringe Pump
- Alaris™ GH Guardrails™ Syringe Pump
- Alaris™ GH Syringe Pump

Note: All the above products are hereinafter referred to as Pump except where different features are applicable then the specific pump will be stated or symbol used, see 'Conventions used in this Manual' section.

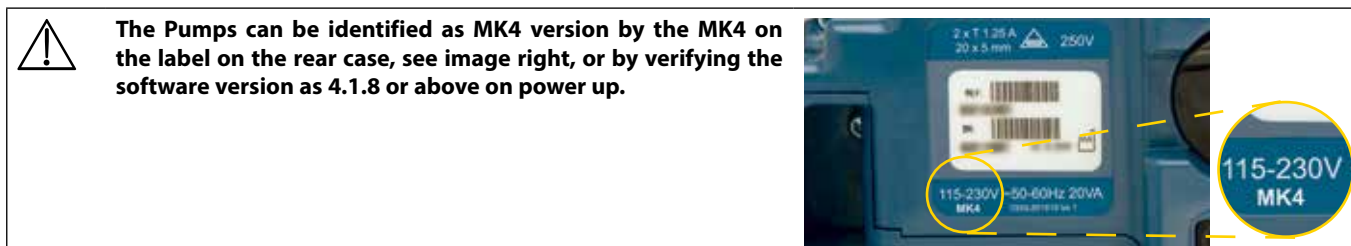

All the pumps above mentioned function with a wide range of standard, single-use, disposable Luer lock syringes together with extension sets. The pump accepts syringe sizes from 5ml to 50ml. A full list of recognised syringes can be found in the 'Recognised Syringes' section. A list of recommended extension sets can be found in the 'Compatible Extension Sets' section. The Alaris Editor software for the pump allows the hospital to develop a best-practice data set of intravenous (IV) medication dosing guidelines for patient-specific care areas, referred to as profiles. Each profile contains a specific library of drugs, as well as pump configurations appropriate for the care area. A profile also contains Hard Limits that cannot be overridden during infusion programming.

The Alaris CC Guardrails Syringe Pump and the Alaris GH Guardrails Syringe Pump profiles also contain Guardrails Soft Alerts that can be overridden, based on clinical requirements. The hospital defined data set is developed and approved through pharmacy and clinical input, and then configured into the pump by qualified technical personnel.

The Alaris CC Guardrails Syringe Pump and the Alaris GH Guardrails Syringe Pump, with a data set loaded, provides automatic alerts when a dosing limit, bolus limit, concentration limit, or weight limit has been exceeded. These safety alerts are provided without the need for the pump to be connected to a PC or network.

The Alaris CC Guardrails Syringe Pump and the Alaris CC Syringe Pump feature an in-line pressure sensor technology, capable of highly accurate, real time pressure monitoring. Improving the early detection of occlusions, by reducing time to alarm, and preventing the potential risk of post occlusion bolus.

Intended Purpose

The Alaris Syringe Pump is intended for use by medical staff for purposes of controlling infusion rate and volume.

Conditions of Use

The Alaris Syringe Pump should only be operated by a clinician competent in use of automated syringe pumps and post-placement management of intravenous catheters.

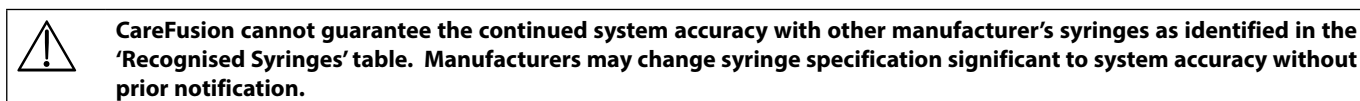

Indications

The Alaris Syringe Pump is indicated for infusion of therapeutics including:

- analgesics
- antimicrobials
- blood products
- chemotherapy
- nutrition
- subcutaneous
- epidural (Alaris CC Syringe Pump and Alaris CC Guardrails Syringe Pump only)

Contraindications

The Alaris Syringe Pumps are contraindicated for:

- enteral therapies
- epidural infusion therapies (Alaris GH Syringe Pump and Alaris GH Guardrails Syringe Pump only)

About This Manual





Users are advised to read, to understand this manual and to be thoroughly familiar with the pumps prior to operating.

All illustrations used in this manual show typical settings and values which may be used in setting up the functions of the pump. These settings and values are for illustrative use only. Where stated, a minimum infusion rate refers to a nominal rate of 1.0ml/h, and an intermediate infusion rate refers to a nominal rate of 5.0ml/h. The complete range of infusion rates, settings and values are shown in the 'Specifications' section.



It is important to ensure that you only refer to the most recent version of the Directions for Use and Technical Service Manual for your CareFusion products. These documents are referenced on www.carefusion.com. Copies can be obtained by contacting your local CareFusion representative.

Conventions used in this manual

BOLD	Used for Display names, software commands, controls and indicators referenced in this manual, for example, Battery Indicator, PURGE, ON/OFF button.
'Single quotes'	Used to indicate cross-references made to another section of this manual.
<i>Italics</i>	Used to refer to other documents or manuals and also used for emphasis.
	This symbol indicates that the option is relevant for the Alaris CC Syringe Pump and the Alaris CC Guardrails Syringe Pump only.
	This symbol indicates that the option is relevant for the Alaris GH Syringe Pump and the Alaris GH Guardrails Syringe Pump only.
	This symbol indicates that the option is relevant for the Alaris CC Guardrails Syringe Pump and the Alaris GH Guardrails Syringe Pump only.
	Important Information: Wherever this symbol is shown an Important note is found. These notes highlight an aspect of use that is important for the user to be aware of when operating the pump.

Creating a Data Set

To create a data set for the pump, first the hospital will need to develop, review, approve and upload a data set according to the following process. Refer to the Alaris Editor help file for further details and operating precautions.

1. Create a new Data Set (Using the Alaris Editor)

- Select new data set type:
 - a) Plus Data Set - to create a new data set for the Alaris GH Syringe Pump or the Alaris CC Syringe Pump
 - b) Plus Guardrails Data Set - to create a new data set for the Alaris GH Guardrails Syringe Pump or the Alaris CC Guardrails Syringe Pump

2. Master Lists (Using the Alaris Editor)

- Master Drugs
A predefined list of drug names and concentrations. This list, as well as alternate names and concentrations defined in the Master Drug List, will be accessible when creating a Profile Drug Library
- Master Syringe Library
A predefined list of the currently supported syringes available for selection within the profile

3. Create Care Area Profiles (Using the Alaris Editor)

- Drug Library
Drugs and concentrations for a Profile with defaults, minimum limits, maximum limits and occlusion alarm level. Up to 100 drug set-ups can be entered for each of the available 30 Profiles.
- Configuration
Pump configuration settings, General Options and Units for Dosing Only.

4. Review, Approve and Export Data Set (Using the Alaris Editor)

- Review and Approve
It is recommended that the entire data set report is printed, reviewed and signed as proof of approval by an authorised person, according to hospital protocol. A signed copy of the data set report should be archived by the hospital for future reference. Once a data set has been agreed it must be approved within the Alaris Editor using a secure password.
- Export
Export data set to allow data set to be uploaded to a pump by the Alaris Transfer Tool.

5. Upload data set to the pump (Using the Alaris Transfer Tool)

Note: Selection of one profile will be required when uploading the data set to the Alaris GH Syringe Pump or the Alaris CC Syringe Pump.

6. Prior to clinical use, check that the Data Set ID on the approved data set report matches the Data Set ID shown on the pump.
7. Switch the pump off.
8. Switch the pump on and verify that the software version screen displays the correct data set version. The pump is now ready to use.







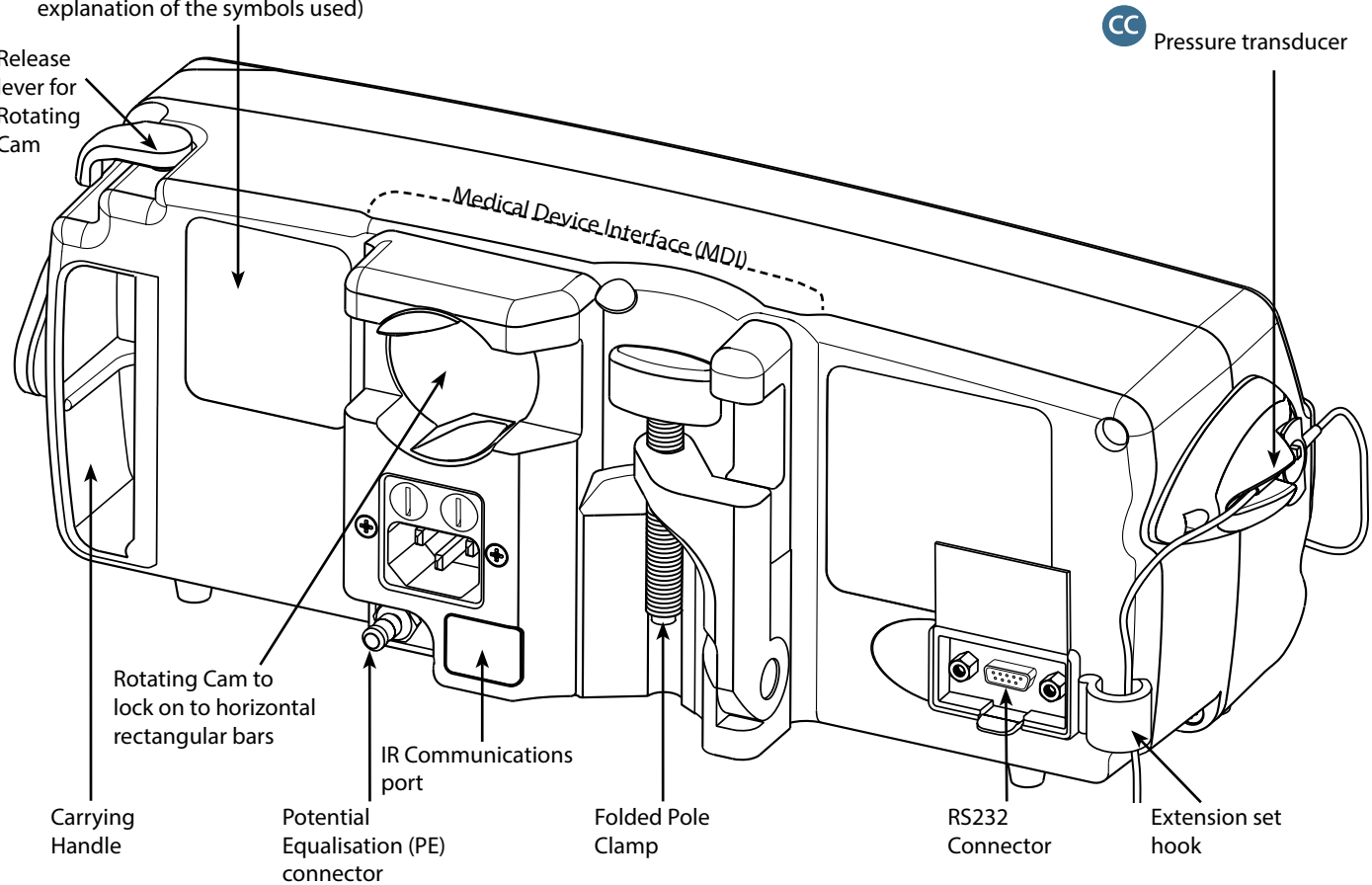
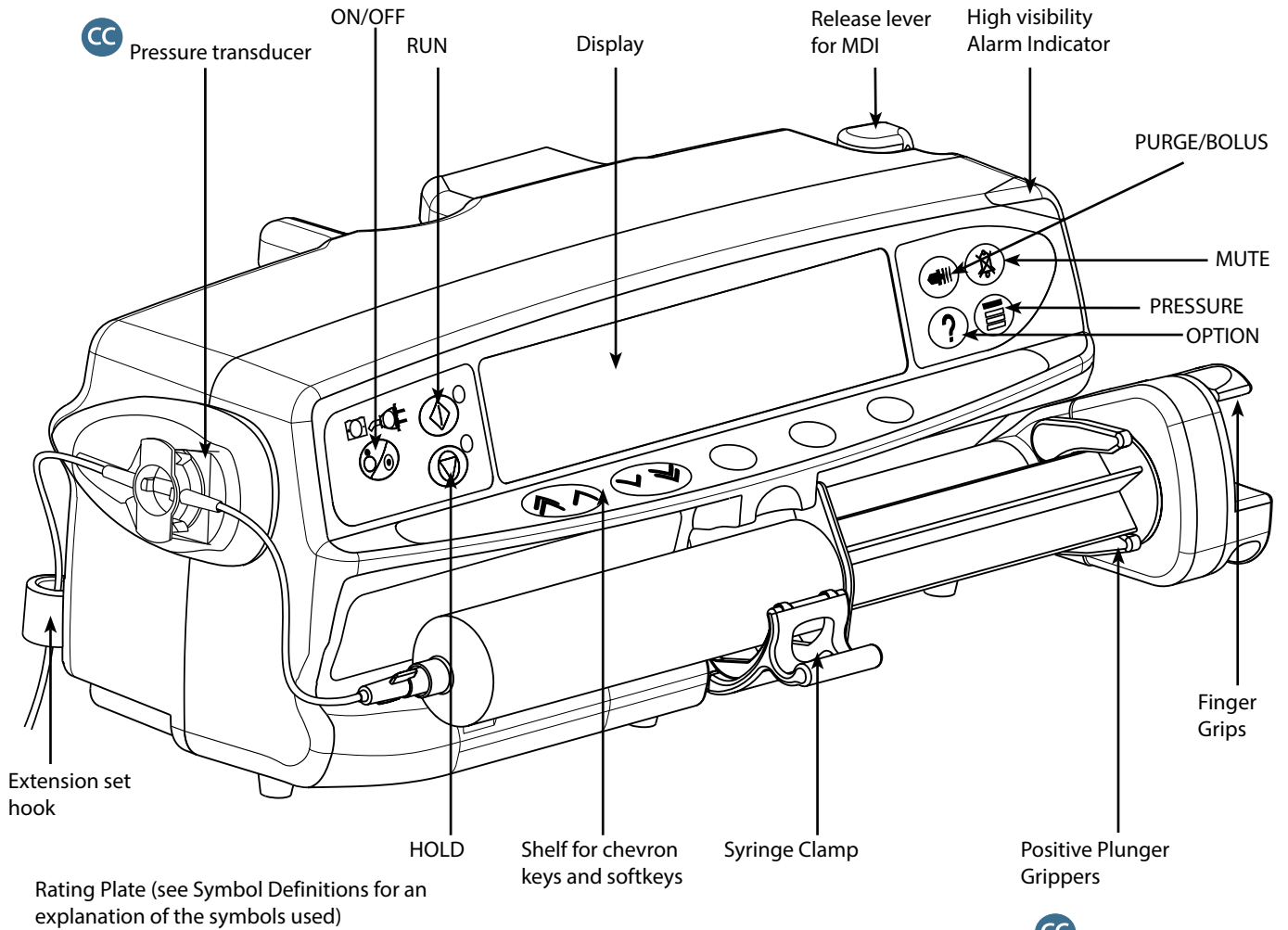





**Drug parameters have to be in accordance to local protocols and prescribed information.
Data set transfers should only be performed by qualified technical personnel.**

Features of the Pump





Controls and Indicators

Controls:













Symbol	Description
	ON/OFF button - Press once to switch the pump ON. Press and hold down for 3 seconds to switch the pump OFF.
	RUN button - Press to start the infusion. The green LED will flash during infusion.
	HOLD button - Press to put the infusion on hold. The amber LED will be lit while on hold.
	MUTE button - Press to silence alarm for two minutes (configurable). When not in alarm press and hold until three audible 'beeps' are sounded for 15 minutes silence.
	<p>PURGE/BOLUS button - Press to access PURGE or BOLUS soft keys. Press and hold down soft key to operate.</p> <p>PURGE - primes the extension set with fluid or drug during initial set up.</p> <ul style="list-style-type: none"> • Pump is on hold • Extension set must not be connected to the patient • Volume Infused (VI) is not added <p>BOLUS - fluid or drug delivered at an accelerated rate.</p> <ul style="list-style-type: none"> • Pump is infusing • Extension set should be connected to the patient • VI is added
	OPTION button - Press to access optional features, see 'Basic Features' section.
	<p>PRESSURE button - Use this button to display the pumping pressure and alarm level.</p> <p> This button will also display the pressure trend display.</p>
	CHEVRON keys - Double or single for faster/slower increase or decrease of values shown on display.
	BLANK SOFTKEYS - Use in conjunction with the prompts shown on the display.

Indicators:

Symbol	Description
	BATTERY indicator - When illuminated the pump is running on the internal battery. When flashing the battery power is low with less than 30 minutes of use remaining.
	AC POWER indicator - When illuminated the pump is connected to an AC power supply and the battery is being charged.

Symbol Definitions

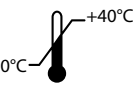
Labelling Symbols:

Symbol	Description
	Consult accompanying documents
	Potential Equalisation (PE) Connector
	RS232/Nurse call Connector
	Defibrillation-proof type CF applied part (Degree of protection against electrical shock)
IP32	Protected against direct sprays of water up to 15° from vertical and protected against solid objects greater than 2.5mm. Note: IP33 applies if AC power cable retainer kit, part number 1000SP01294, is fitted.
	Alternating Current
	Device complies with the requirements of Council Directive 93/42/EEC as amended by 2007/47/EC.
	Date of Manufacture
	Manufacturer
	Not for Municipal Waste
	Fuse Rating
	Operating Temperature Range - Pump can be used between 0 and 40 degrees centigrade.
	Authorised representative in the European Community

Main Display Features

Alaris CC Syringe Pump and Alaris CC Guardrails Syringe Pump Display CC

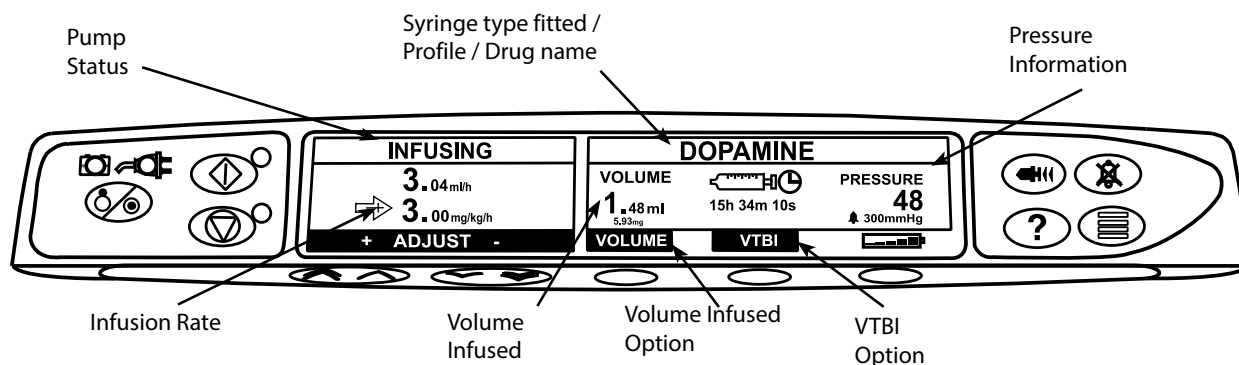

Alaris GH Syringe Pump and Alaris GH Guardrails Syringe Pump Display GH

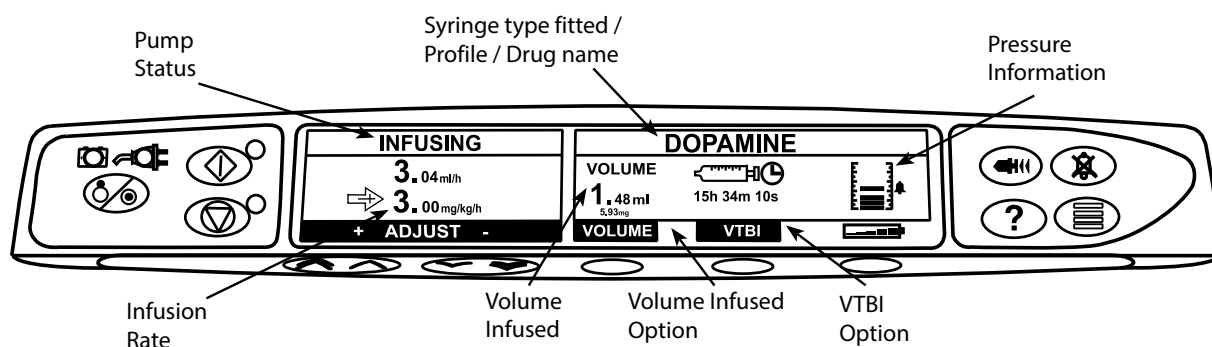

Screen Icons

Symbol	Description
	Time remaining display icon - Indicates time before syringe will require replacement.
	BATTERY icon - Indicates battery charge level to highlight when the battery will require recharging or re-connection to mains power supply.
↑INFUSING↑	Guardrails Soft Alert icons - Indicates the pump is running at a rate or dose above (pointing up) or below (pointing down) a Guardrails Soft Alert.
↓INFUSING↓	Guardrails
	Hard limit Warning icon - Indicates the setting entered is not permitted as it is under or exceeds a Hard Limit.

Operating Precautions

Disposable Syringes and Extension Sets



- The pump has been calibrated for use with single-use disposable syringes. To ensure correct and accurate operation, only use 3 piece Luer lock versions of the syringe make specified on the pump or described in this manual. Use of non-specified syringes or extension sets may impair the operation of the pump and the accuracy of the infusion.



- Uncontrolled flow or syphoning may result if the syringe is located incorrectly in the pump, or if it is removed from the pump before the extension set is properly isolated from the patient. Isolation may include closing a tap in the patient line or activating a flow stop clamp.
- The user must be thoroughly familiar with instructions in this Directions For Use and understand how to load and confirm the syringe on the pump. Incorrect syringe loading may result in misidentification of the syringe type and size leading to significant under or over infusion.



- Secure the extension set to the pump using the extension set hook at the rear of the pump. This provides protection against accidental dislodging of the syringe from the pump.



- When combining several apparatus and/or instruments with extension sets and other tubing, for example via a 3-way tap, the performance of the pump may be impacted and should be monitored closely.

- Always clamp or otherwise isolate the patient line before unclamping or removing a syringe from the pump. Failure to do so may result in unintended administration.

Mounting the Pump

- When more than one pump is being used on a patient, those containing high risk, critical medications must be positioned as close to the patient's heart level as possible to avoid the risk of variations in flow or siphoning.
- Raising a pump whilst infusing may result in a bolus of the infusate, whereas lowering a pump whilst infusing may result in a delay in the infusion (an underinfusion).
- Do not mount the pump in a vertical position with the syringe pointing upwards as this could lead to an infusion of air which may be in the syringe. To protect against the introduction of air the user should regularly monitor the progress of the infusion, syringe, extension line and patient connections and follow the priming procedure specified herein.



Operating Environment

- Intended environments include general wards, critical and intensive care, operating rooms, accident and emergency rooms. The pump may be used in an ambulance environment. Ensure that the pump is appropriately attached using the provided pole clamp. The pump is designed to withstand possible bumps and vibrations whilst being used in an ambulance, complying with the standard EN 1789. If the pump is dropped or experiences any severe physical disturbances, arrange a thorough inspection by appropriately trained technical personnel as soon as is practically possible. The pump may also be used outside the ambulance as long as the temperature is within the specified range as stated in the 'Specifications' section and on the pump label.
- When using any infusion pump in conjunction with other pumps or devices requiring vascular access, extra care is necessary. Adverse delivery of medication or fluids can be caused by the substantial variation in pressures created within the infusion system by such pumps. Typical examples of those pumps are used during dialysis, bypass or cardiac assist applications.
- The pump is suitable for use in Hospital and clinical environments other than domestic establishments and those directly connected to the public single phase AC mains power supply network that supplies buildings used for domestic purposes. However, it may be used in domestic establishments under the supervision of Medical professionals with additional necessary appropriate measures. (Consult *Technical Service Manual*, appropriately trained technical personnel or CareFusion for further information).
- The pump is not intended to be used in the presence of a flammable anaesthetic mixture with air or oxygen or nitrous oxide.

Operating Pressure

- This is a positive pressure pump designed to achieve very accurate fluid administration by automatically compensating for resistance encountered in the infusion system.
- The pumping pressure alarm system is not designed to provide protection against, or detection of, IV complications which can occur.

Alarm Conditions

- Several alarm conditions detected by this pump will stop the infusion and generate visual and audible alarms. Users must perform regular checks to ensure that the infusion is progressing correctly and no alarms are operating.



Guardrails

Guardrails Safety Software

- The Guardrails Safety Software incorporates soft dosing limits and pump configuration parameters based on hospital protocol. The software adds a test of reasonableness to drug programming based on the limits defined by the hospital. Qualified personnel must ensure the appropriateness of the drug dosing limits, the compatibility of the drugs, and the performance of each pump, as part of the overall infusion. Potential hazards include drug interactions, and inappropriate delivery rates and pressure alarms.
- When loading a data set with the Guardrails Safety Software, the user must ensure the correct profile is selected prior to starting an infusion.

Hazards



- An explosion hazard exists if the pump is used in the presence of flammable anaesthetics. Exercise care to locate the pump away from any such hazardous sources.



- Dangerous Voltage: An electrical shock hazard exists if the pump's casing is opened or removed. Refer all servicing to qualified service personnel.



- When connected to an external power source, a three-wire (Live, Neutral, Earth) supply must be used. If the integrity of the external protective conductor in the installation or its arrangement is in doubt, the pump should be operated from the battery.
- Do not open the RS232/Nurse Call protective covering when not in use. Electrostatic discharge (ESD) precautions are required when connecting RS232/Nurse Call. Touching the pins of the connectors may result in ESD protection failure. It is recommended that all actions must be taken by appropriately trained personnel.

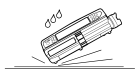

- If the pump is dropped, subjected to excessive moisture, fluid spillage, humidity or high temperature, or otherwise suspected to have been damaged, remove it from service for inspection by a qualified service engineer. When transporting or storing the pump, use original packaging where possible, and adhere to temperature, humidity and pressure ranges stated in the 'Specifications' section and on the outer packaging.
- Warning: Alaris Syringe Pumps should not be modified or altered in any way, except where explicitly directed or authorised by CareFusion. Any use of Alaris Syringe Pumps which have been altered or modified otherwise than in strict application of directions provided by CareFusion, is at your sole risk, and CareFusion does not provide any warranty for or endorsement on any Alaris Syringe Pump that has been so modified or altered. CareFusion's product warranty shall not apply in the event the Alaris Syringe Pump has suffered damage or premature wear, or malfunctions or otherwise operates incorrectly, as a result of unauthorised modification or alteration of the Alaris Syringe Pump.
- Care must be taken when removing covers or handling moving mechanisms.

Electromagnetic Compatibility & Interference



- The pump is protected against the effects of external interference, including high energy radio frequency emissions, magnetic fields and electrostatic discharge (for example, as generated by electrosurgical and cauterising equipment, large motors, portable radios, cellular telephones etc.) and is designed to remain safe when unreasonable levels of interference are encountered.
- Therapeutic Radiation Equipment: Do not use the pump in the vicinity of any Therapeutic Radiation Equipment. Levels of radiation generated by the radiation therapy equipment such as Linear Accelerator, may severely affect functioning of the pump. Please consult manufacturer's recommendations for safe distance and other precautionary requirements. For further information, please contact your local CareFusion representative.
- Magnetic Resonance Imaging (MRI): The pump contains ferromagnetic materials which are susceptible to interference with magnetic field generated by the MRI devices. Therefore, the pump is not considered an MRI compatible pump as such. If use of the pump within an MRI environment is unavoidable, then CareFusion highly recommends securing the pump at a safe distance from the magnetic field outside the identified 'Controlled Access Area' in order to evade any magnetic interference to the pump; or MRI image distortion. This safe distance should be established in accordance with the manufacturers' recommendations regarding electromagnetic interference (EMI). For further information, please refer to the product *Technical Service Manual (TSM)*. Alternatively, contact your local CareFusion representative for further guidance.
- Accessories: Do not use any non-recommended accessory with the pump. The pump is tested and compliant with the relevant EMC claims only with the recommended accessories. Use of any accessory, transducer or cable other than those specified by CareFusion may result in increased emissions or decreased pump immunity.
- This pump is a CISPR 11 Group 1 Class A device and uses RF energy only for its internal function in the normal product offering. Therefore, its RF emissions are very low and are not likely to cause any interference with the nearby electronic equipment. However, this pump emits a certain level of electromagnetic radiation which is within the levels specified by *IEC/EN60601-1-2* and *IEC/EN60601-2-24*. If the pump interacts with other equipment, measures should be taken to minimise the effects, for instance by repositioning or relocation.
- In some circumstances the pump may be affected by an electrostatic discharge through air at levels close to or above 15kv; or by radio frequency radiation close to or above 10v/m. If the pump is affected by this external interference the pump will remain in a safe mode; the pump will duly stop the infusion and alert the user by generating a combination of visual and audible alarms. Should any encountered alarm condition persist even after user intervention, it is recommended to replace that particular pump and quarantine the pump for the attention of appropriately trained technical personnel. (Consult *Technical Service Manual* for further information).



Getting Started



Initial Set-up



Before operating the pump read this Directions For Use manual carefully.

1. Check that the pump is complete, undamaged and that the voltage rating specified on the label is compatible with your AC power supply.
2. Items supplied are:
 - Alaris Syringe Pump
 - User Support CD (Directions For Use)
 - AC Power Cable (as requested)
 - Protective Packaging
3. Connect the pump to the AC power supply for at least 2½ hours to ensure that the internal battery is charged (verify that the  is lit).

Language Selection

1. On initial start-up the pump will display the Select Language screen.
2. Select the required language from the list displayed using the   keys.
3. Press the **OK** softkey to confirm your selection.



- **The pump may be used safely with the pre-installed default data set. Any data set created for installation must be approved by an appropriately qualified person with clinical authority in accordance with hospital protocol prior to upload and activation.**
- **The pump will automatically operate from its internal battery if the pump is switched on without being connected to the AC power supply.**
- **Should the pump fail to perform correctly, replace in its original protective packaging, where possible and contact a qualified service engineer for investigation.**



Do not mount the pump with the AC power inlet or the syringe pointing upwards. This could affect the electrical safety in the event of a fluid spill or lead to the infusion of air which may be in the syringe.

Pole Clamp Installation

The pole clamp is fitted to the rear of the pump and will provide secure fixing to vertical I.V. poles of a diameter between 15 and 40 mm.

1. Pull the folded pole clamp towards you and unscrew the clamp to leave enough room for the size of the pole.
2. Place pump around pole and tighten screw until the clamp is secured to the pole.



Ensure the pole clamp is folded away and stored within the recessed area at the rear of the pump before connecting to a Docking Station/Workstation* or when not in use.

Never mount the pump such that the I.V. infusion stand becomes top heavy or unstable.

Recessed area

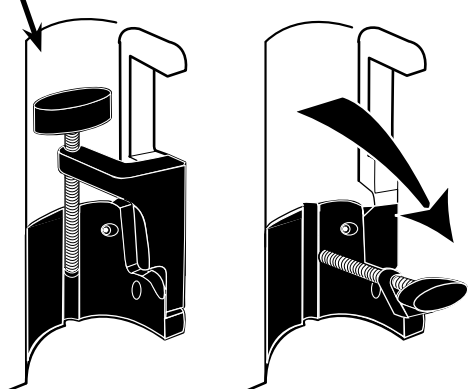

Prior to each use, check the pole clamp:

- does not show any signs of excessive wear,
- does not show any signs of excessively loose movement in the extended, mountable position.

If these signs are observed, the pumps should be taken out of service for examination by qualified service personnel.

Docking Station/Workstation* or Equipment Rail Installation

The rotating cam can be fitted to the rectangular bar on the Docking Station/Workstation* or the equipment rail measuring 10 by 25mm.

1. Align the rotating cam on the rear of the pump with the rectangular bar on the Docking Station/Workstation* or the equipment rail.
2. Hold the pump horizontally, push the pump firmly onto the rectangular bar or equipment rail.
3. The pump should *click* into position when fitted to the bar.
4. Ensure that the pump is positioned securely. Verify Pump is secure by gently pulling the Pump away from the Docking Station/Workstation* without using the release lever. When the Pump is securely attached, it should not come off the Docking Station/Workstation*.
5. To release, push the release lever and pull the Pump forwards.

Warning: Pump may fall off the Docking Station/Workstation* if not properly mounted which could result in user and/or patient harm.

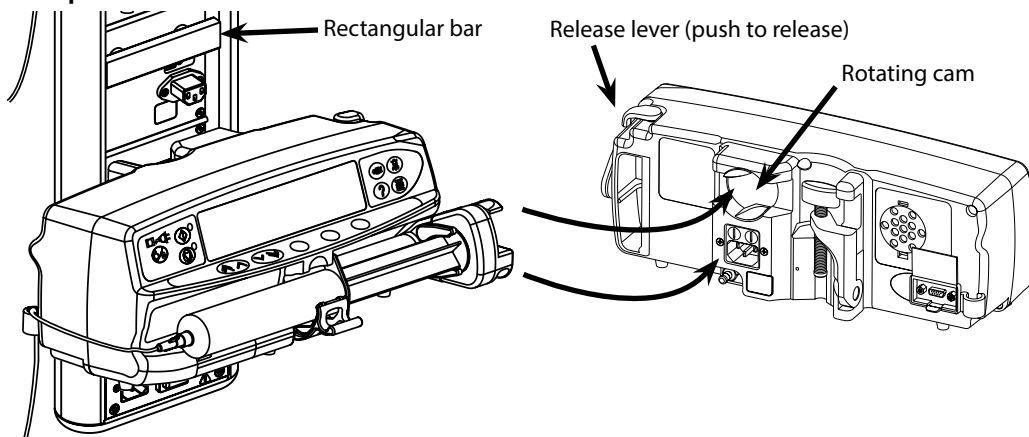

* Alaris Gateway Workstation and Alaris DS Docking Station

Securing the Syringe with Optional Lock box

Lock box operation

The optional lock box is available in two configurations:

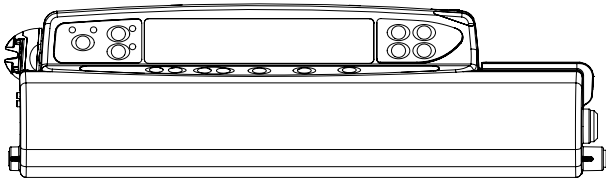

- Rate Unlocked lock box - is designed to allow the user to adjust rate whilst infusing.

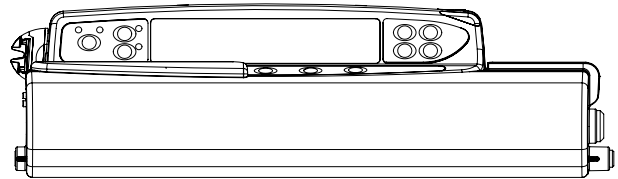

- Rate Locked lock box - is designed to prevent rate change whilst infusing. If using this lock box users would need to put the Pump on hold and open the lock box to change the rate.



When mounting a Pump with lock box ensure that there is sufficient clearance for the cover to be fully opened, a gap of 130mm minimum below the Pump is recommended.

Open Lock box:

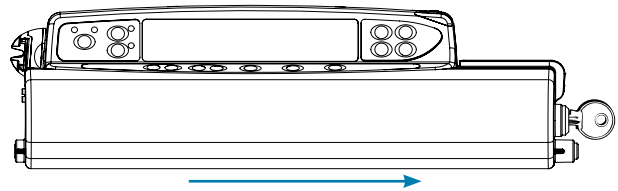
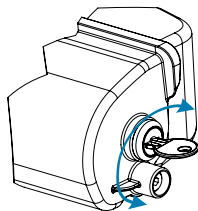

1. Insert the key into the lock and turn key either way to unlock.
2. Lock box will move to the right and can then be opened.

Close Lock box:

1. Load the syringe according to the instructions in the 'Loading and Confirming a Syringe' section.
2. Ensure the extension set is connected to the syringe and threaded through the lock box.
Note: For the Alaris CC Syringe Pump models the pressure disc must be fitted prior to closing the lock box.
3. Set up the Pump according to the instructions in the 'Starting the Pump' section prior to closing the lock box for the Rate Locked version only.

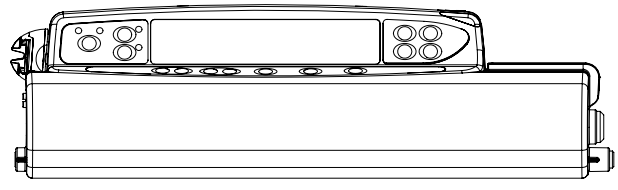
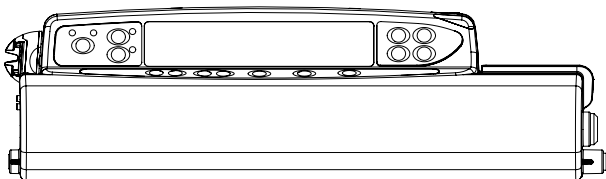

4. Close the cover until it makes contact with the pump case.
5. Push the lock box from right to left until a click is heard.

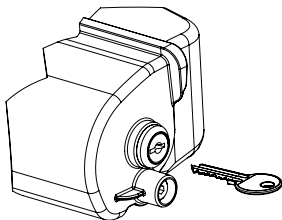

6. Remove the key.



- **When transporting the Pump with lock box fitted it is recommended that two hands are used when holding or carrying the Pump.**
- **If lock or lock box appears to be damaged, remove the pump from service for examination by qualified service personnel.**
- **When the Pump is not in use ensure the lock box is locked.**
- **Lock box keys should be stored separately and take care not to lock keys inside lock box.**
- **Refer to the 'Routine Maintenance' section for instructions on cleaning and maintenance.**

Syringe Loading

Prepare Syringe and Administration Set

To decrease potential start-up delays, delivery inaccuracies and delayed generation of occlusion alarms each time a new syringe is loaded:

- Use smallest syringe size possible, for example, if infusing 9 ml of fluid, use a 10 ml syringe.
- Use the PURGE SYRINGE or PURGE option on the Pump to decrease the delay in the start of the infusion, see Starting the Pump section.



Warning: Use the smallest compatible syringe size necessary to deliver the fluid or medication; this is especially important when infusing high risk or life-sustaining medications at low infusion rates, especially flow rates < 0.5 ml/h.



Warning: Purge the Pump system before starting an infusion or after replacing a near-empty syringe with a replacement syringe. When Purging ensure that the extension set is not connected to the patient.

Practice Recommendations:

- Tubing internal diameter: Smallbore or microbore tubing is recommended when infusing at low rates
- Filters: Internal volume, dead space, of in-line filters should be minimized
- Connection sites: Critical drugs should be connected as close to the vascular access site as possible

Positioning of Pump

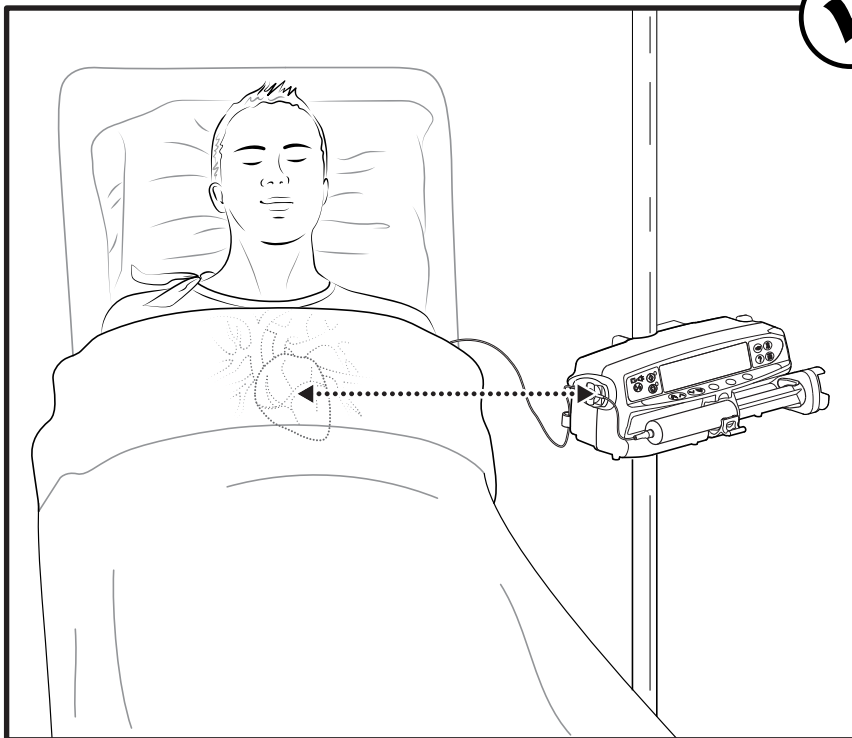

Ensure that the Pump is as close to level of patient's heart as possible.

Patient's heart level should be in line with the middle of the Pump or the pressure disc for the Alaris CC Syringe Pumps.



Warning: Adjusting the Pump's height relative to the patient's heart level can lead to temporary increases or decreases in fluid delivery



Caution: If using multiple syringe pumps and it is not clinically feasible to have all Pumps level with the patient's heart, place the high risk or life-sustaining medications as close to the patient's heart level as possible.



Caution: When infusing multiple high risk or life-sustaining medications, consider placing the Pumps infusing at the lowest rates as close to the level of the patient's heart as possible.

Loading and Confirming a Syringe



Warning: To securely load and confirm a syringe carefully follow the steps below. An incorrect loading of a syringe may result in misidentification of the syringe type and size. If then confirmed, this may lead to significant inaccuracy of the infusion rate and may also affect pump performance.

Only use a syringe of the type stated on the pump or in this manual. Using an incorrect syringe could adversely affect the accuracy of the infusion rate and may also affect pump performance.

When drawing fluid into the syringe, draw enough to compensate for any dead space volume in the extension set and syringe at the end of infusion as this cannot be fully infused.

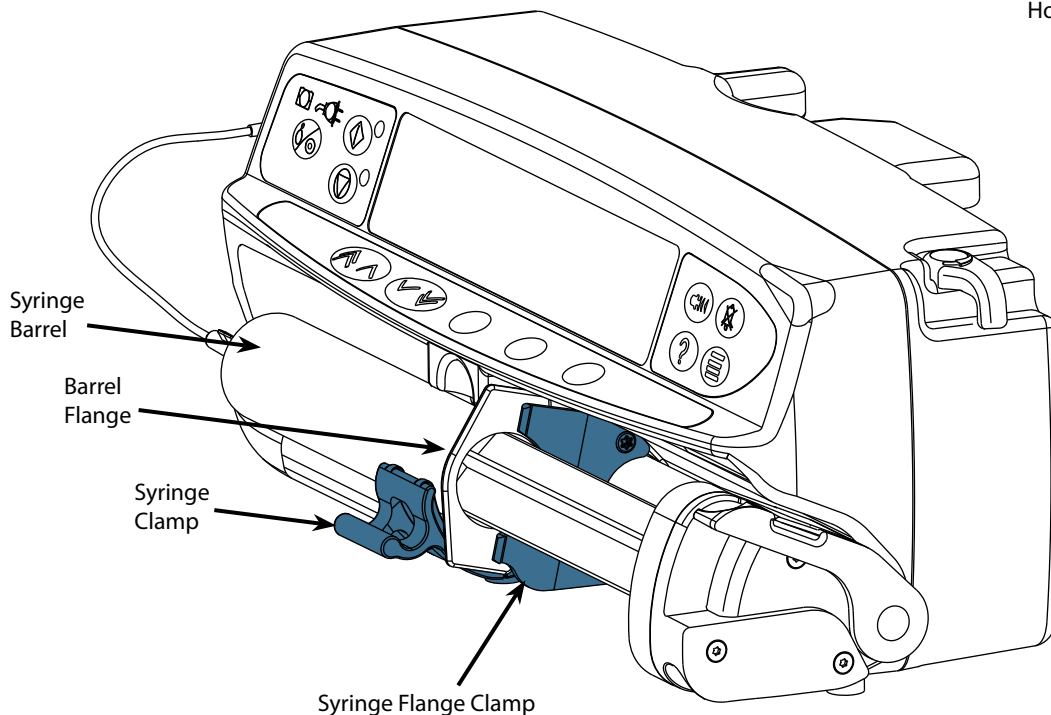
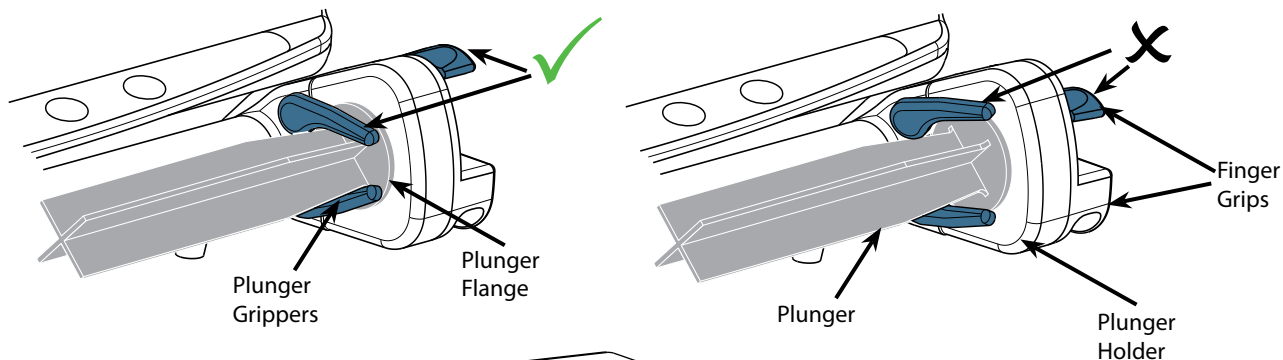

Place the pump on a stable horizontal surface or secure as described previously.

Prepare, load and prime the single-use disposable syringe and extension set using standard aseptic techniques.

1. Squeeze the finger grips together on the plunger holder and slide the mechanism to the right.
2. Pull the syringe clamp forward and down.



3. Insert the syringe ensuring that the barrel flange is located in the slots on the syringe flange clamp.



To ensure the syringe is loaded correctly, place the barrel flange in the space between the syringe clamp and the syringe flange clamp. This is correct if the syringe remains in position before the syringe clamp is closed.

4. Lift the syringe clamp until it locks against the syringe barrel.



5. Squeeze the finger grips on the plunger holder and slide the mechanism to the left until it reaches the plunger end.

6. Release the finger grips. Ensure that the plunger grippers are securing the plunger in place and the finger grip returns to its original position.



7. Ensure that the syringe type and size match those displayed on the pump then press **CONFIRM**. If required, the make of syringe can be changed by pressing the **TYPE** softkey.

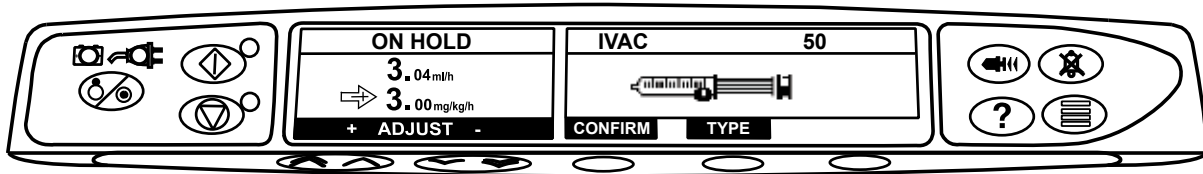

Note: If the **PURGE SYRINGE** option has been enabled then the prompt to purge screen is displayed and the extension set can be purged as required, however ensure that the extension set is not connected to the patient during this process.



CareFusion recommends limiting the number of configured syringe types and sizes available for selection on the pump using the Alaris Editor.

Secure the extension set using the extension set hook at the rear of the pump. This provides protection against accidental dislodging of the syringe from the pump.

Ensure that both plunger grippers are fully locked onto the plunger flange and the upper finger grip has returned to its original position.



Fast Start is a Pump feature to automatically reduce the mechanical slack between the plunger mechanism and syringe at the start of an infusion, as required.

Starting the Pump

1. Connect the pump to an AC power supply using the AC power cable.
2. Press the  button.
 - The pump will run a short self-test.



Warning: two beeps are activated during this self-test and the red alarm beacon illuminates and then clears. No action is required during this self-test.

- Check the display test pattern and ensure that no rows are missing.
- Check that the displayed time and date are correct.
- Finally check display shows the data set name, version number and released date and time.

Note: A warning - **REPAIRING LOGS**, may be displayed if event log information was not completely stored at the previous power down. This is for information only, the pump will continue to power up as normal.

3. CLEAR SETUP

- Selecting **NO** will keep previous setup and go to step 8.
- Selecting **YES** will clear previous setup and will go to step 4.



Clear setup screen will only be displayed if a previous setup was used.

4. CONFIRM PROFILE

Note: The **CONFIRM PROFILE** screen will not be displayed for the Alaris GH Syringe Pump, the Alaris CC Syringe Pump or if there is only one profile available in the data set.

- a) **NO** will display select profile screen
 - Select profile from list, if required press **ALL** to update the list displayed to include all the profiles within the data set.
 - Press **OK** to confirm.



ALL softkey will only be displayed if there are some profiles in the data set not being displayed, since their selectable status is disabled.

- b) **YES** will display drug select screen or clear setup screen.

5. DRUG SELECT? - Select one of the following:

Note: The **DRUG SELECT** screen will not be displayed if there are no drugs setup in the profile.

- **ml/h** - allows infusions to be given in ml/h only, after selecting **OK** to confirm. Go to step 8.
- **DOSING ONLY** - enables the pump to be set-up with a dosing protocol, after selecting **OK** to confirm. Go to step 6.



No concentration or dose rate limits are used when ml/h or DOSING ONLY modes are selected.

- **DRUG NAME** - select a drug name from profile's drug library, after selecting **OK** to confirm. Go to step 7.

Note: Drugs are listed in alphabetical groups as follows: A-E, F-J, K-O, P-T and U-Z. Select group containing the drug name required and then the required drug and all other drugs can be seen.

6. DOSING ONLY -

- a) Select Dosing unit and **OK** to confirm.
- b) Select Concentration Amount and **OK** to confirm. Use **UNITS** softkey to change concentration unit, if required.
- c) Select Total Volume to be used and **OK** to confirm.
- d) Adjust Weight and **OK** to confirm, if required.
- e) Press **OK** to confirm dosing information. Go to step 8.

7. DRUG NAME -

- a) Select Concentration required, press **OK** to confirm Concentration or **MODIFY** to change Drug amount and total volume to be used. If the dose amount and total volume are not defined in the data set then they will need to be set as follows:
 - Adjust dose amount and **OK** to confirm. Use **UNITS** softkey to change concentration unit, if required.
 - Adjust Total Volume and **OK** to confirm
- b) Adjust Weight and **OK** to confirm, if required.
- c) Press **OK** to confirm setup. Go to step 8.



Steps for Drug Name setup may vary dependant on how the profile is configured in the Alaris Editor.

8. Load the syringe according to the procedure in this manual.

9. Insert the pressure disc into the pressure transducer. 



Pressure Transducer - Detects if an extension set with a pressure disc is fitted. The pressure transducer will measure positive pressures within the extension set.

Warning - To remove or insert pressure disc from or into pressure transducer assembly, insert finger into the recess in the pressure disc and pull forward or push back with care. Do not pull the extension set to remove or to insert the pressure disc.

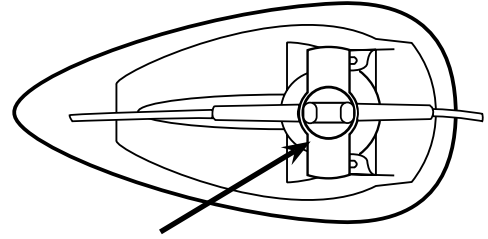



10. Ensure that the syringe type and size match those displayed on the pump then press **CONFIRM**. If required, the make of syringe can be changed by pressing the **TYPE** softkey.

Note: If the **PURGE SYRINGE** option has been enabled then the prompt to purge screen is displayed and the extension set can be purged as required, however ensure that the extension set is not connected to the patient during this process..

11. Purge (if required) - Press the  button and then press and hold the **PURGE** softkey until fluid flows and the purging of the extension set is complete. Release the softkey. The volume used during purging will be displayed.



Purge extension set, massaging pressure disc to prevent ballooning and ensuring all air removal.

12. Check the rate shown if set and change the rate if necessary using the   keys.

13. Connect the extension set to the patient access device.

14. Press  to commence operation.

- The *amber stop* light will be replaced by the flashing *green start* light to indicate that the pump is in operation. **INFUSING** will be displayed.

Note: If infusion rate exceeds the Hard Limit then the pump will not start and the display will show **DOSE NOT PERMITTED**.

Guardrails

- If the infusion settings are within the Guardrails Soft Alerts then the *amber stop* light will be replaced by the flashing *green start* light to indicate that the pump is in operation. **INFUSING** will be displayed.

Note: If infusion rate exceeds or is under the Guardrails Soft Alerts then check infusion setting, to continue with infusion at set rate press  and then confirm **OVERRIDE LIMIT** by pressing **YES**. If **OVERRIDE LIMIT** is not required press **NO** and adjust rate to be within the Guardrails Soft Alerts.



If infusion rate running exceeds or is under the Guardrails Soft Alerts then the display will show INFUSING with either Up or Down arrows on both sides.

15. Press  to halt the operation. **ON HOLD** will be displayed. The *amber stop* light will replace the *green start* light.



- Fully Dedicated - to start an infusion a pressure disc must be fitted.**
- Semi Dedicated - to start an infusion with DRUG NAME or DOSING ONLY selected a pressure disc must be fitted.**

Basic Features

Bolus Infusion

Bolus Administering a controlled volume of fluid or drug at an increased rate for diagnostic or therapeutic purposes. The pump should always be infusing and always attached to the patient. (Drugs given by an IV bolus could achieve immediate and high drug concentration levels.)

Bolus can be used at the start of an infusion or during an infusion.

The bolus feature can be configured to:

- a) BOLUS Disabled
- b) BOLUS Enabled
 - Hands-On only
 - Hands-Free and Hands-On

BOLUS Disabled



If configured to Disabled, pressing the  button will have no effect and the pump will continue to infuse at the set rate.



A Hands-On bolus and Hands-Free bolus cannot be administered if the rate lock is active or if the feature is disabled for the selected Profile or specific drug. During BOLUS the pressure limit alarm is temporarily increased to the maximum level.





BOLUS Enabled - Hands-On

In Hands-On Bolus, press and hold the (flashing) **BOLUS** softkey to deliver the required bolus. The bolus rate can be adjusted. The bolus volume is limited in the configuration.

1. During infusion press the  button once to display the bolus screen.
2. Use the   keys to adjust the bolus rate if required.
3. To deliver the bolus press and hold the **BOLUS** softkey. During the bolus, the volume being infused is displayed. When the desired bolus volume has been delivered or the bolus volume limit is reached, release the softkey. The bolus volume is added to the total volume infused.

BOLUS Enabled - Hands-Free and Hands-On

The Hands-Free Bolus is delivered with a single press of the (flashing) **BOLUS** softkey. The bolus rate and bolus volume are set by drug profile in the data set and can be changed within limits set by the data set.

1. During infusion press the  button to display the Hands-Free bolus selection screen.
2. Press the **YES** softkey to go to Hands-Free selection bolus screen, press the **HANDS ON** softkey for Hands-On bolus (see section above).
3. Use the   keys to set the bolus volume/dose required; If necessary use the **RATE** softkey and the   keys to adjust the bolus delivery rate.

Note: Rate may be restricted by the syringe size and the **CAP BOLUS RATE**.
4. Press the flashing **BOLUS** softkey once to begin the delivery of the preset bolus. The display will show the bolus being delivered, the bolus counting down and revert to main infusion display upon completion of the bolus.
5. To terminate a bolus being delivered press **STOP** softkey. This will stop the bolus and continue infusing at the set rate. Press the  button to stop the bolus delivery and place the pump on hold.
6. If the bolus volume reaches the set bolus volume the bolus will stop and the pump will revert to infuse at the set infusion rate and continue infusing.



If the Hands-Free bolus option is active, then this feature will be cancelled following any interruption in delivery, e.g. occlusion, even if the bolus delivery is incomplete.

If the volume to be infused (VTBI) is reached during a bolus, the VTBI complete alarm will sound. Press  to silence the alarm or CANCEL to acknowledge the alarm. See VTBI section for more details on VTBI operation.

Any Hands-Free Bolus dose setting which exceeds or is under a Guardrails Soft Alert must be confirmed before operation can be continued.*

Manual Bolus

The Manual Bolus is delivered by moving the plunger drive mechanism forward while the pump is infusing. This method of delivering a bolus is not recommended as best clinical practice.

The syringe must be confirmed and the plunger mechanism has to move from an engaged position to disengage and then re-engage position. A minimum travel of 1mm (leadscrew pitch) must be detected to register.

* **Guardrails**

Purge

The  button allows the delivery of a limited volume of fluid in order to purge the extension set prior to being connected to a patient or after changing a syringe.





1. Press the  button when the pump is not infusing. Ensure that the extension set is not connected to the patient.
2. Press and hold the **PURGE** softkey until fluid flows and the purging of the extension set is complete. The volume used during purging will be displayed, but it is not added to the volume infused.
3. When purging is complete release the **PURGE** softkey. Press the **QUIT** softkey to exit back to the main display.



The pump will not purge if the RATE LOCK has been enabled. During PURGE the pressure limit alarms are temporarily increased to their maximum level.

Volume to be Infused (VTBI)

This option allows a specific volume to be infused to be set. Rate at the end of this VTBI can also be set, selecting from stop, KVO, or continuous infusion at the set rate.

1. Press the **VTBI** softkey to select the volume to be infused option.
2. Enter the volume to be infused using the   keys and press the **OK** softkey.
3. Select the rate at the end of the VTBI using the   keys to scroll through the on-screen choices. The default is stop.
4. Press the **OK** softkey to confirm and exit the VTBI menu.

Note: When current VTBI has finished, no other infusion will be allowed unless a new VTBI is set or current VTBI is cleared.

Clear Volume

This option enables the volume infused to be cleared. The Dose Infused for a drug is displayed if the Volume Infused is attributable to a single drug setup. Clearing the volume will display the Dose Infused.

1. Press the **VOLUME** softkey to display the **CLEAR VOLUME** option.
2. Press the **YES** softkey to clear the volume. Press the **NO** softkey to retain the volume.

Note: Selecting **YES** resets the volume infused in the **24H LOG** option.

Rate Lock



If Rate Lock is enabled, when the infusion rate has been set and the infusion started, the rate lock prompt will appear on the display following any rate titrations or bolus infusions.

To select the rate lock function press the **YES** softkey. Press the **NO** softkey if the rate lock is not required.



When rate lock is enabled, the following are unavailable:

- Changing the infusion rate / titration
- Bolus / purge
- Switching the pump off
- VTBI over time infusions.

To disable the rate lock if selected:



1. Press the  button to access the options menu.
2. Select the **UNLOCK RATE** option using the   keys and press the **OK** softkey.

To enable the rate lock if not selected:

1. Press the  button to access the options menu.
2. Select **RATE LOCK** option using the   keys and press the **OK** softkey.

Rate Titration





If Rate Titration is enabled the rate can be adjusted while infusing:

1. Select the new rate using the   keys.
2. The message **< START TO CONFIRM >** will flash on screen and pump continues to infuse at the original rate.
3. Press the  button to confirm the new infusion rate and start infusing at the new rate.

Note: Press the **QUIT** softkey to exit titration and return to original rate.

Note: If the new infusion rate setting exceeds or is under a Guardrails Soft Alert confirmation is required before infusion can start infusing at the new rate.*

If Rate Titration is disabled the rate can only be adjusted whilst on hold:

1. Press the  button to put the pump on hold.
2. Select the new rate using the   keys.
3. Press the  button to start infusing at the new rate.

* **Guardrails**







Dosing Summary

To review currently selected dosing information:

1. Press the  button to first access the options menu.
2. Select **DOSING SUMMARY**.
3. Review the information and then press the **QUIT** softkey.



Set VTBI over Time

This option allows a VTBI and delivery time to be specified. The rate necessary to deliver the required volume within the specified time is calculated and displayed.

1. Stop the infusion. Press the  button to access the options menu.
2. Select the **SET VTBI OVER TIME** option using the   keys and press the **OK** softkey.
3. Adjust the volume to be infused using the   keys. When the desired volume has been reached press the **OK** softkey.
4. Enter the time over which the volume is to be infused. The infusion rate will automatically be calculated. Press the **OK** softkey to enter the value.
5. Select the rate at VTBI end from the list using the   keys and press the **OK** softkey. The default is **STOP**.

24 Hour Log

This option allows the 24 hour log of volume infused to be reviewed.

1. Press the  button to access the options menu.
2. Select the **24H LOG** option using the   keys and press the **OK** softkey.





The display shows the hourly volume infused. The volume infused shown in brackets is the total volume infused since the volume was last cleared. See example below:

```
07:48 - 08:00 4.34ml (4.34ml)
08:00 - 09:00 2.10ml (6.44ml)
09:00 - 10:00 2.10ml (8.54ml)
VOLUME CLEARED
```

3. Press the **QUIT** softkey to exit the log.

Event Log

This option allows the event log to be reviewed, if enabled.

1. Press the  button to access the options menu.
2. Select the **EVENT LOG** option using the   keys and press the **OK** softkey.
3. Scroll through the log using the   keys. Press the **QUIT** softkey to exit the log.

Data Set Details

To review currently selected data set information:

1. Press the  button to access the options menu.
2. Select **DATA SET DETAILS**.
3. Review the information and then press the **QUIT** softkey.

Infusion Setup

To change Infusion Setup

1. Stop the infusion. Press the  button to access the options menu.
2. Select **INFUSION SETUP**.
3. Select Infusion Setup required and press the **OK** softkey.

Pump Details

To review pump information.

1. Press the  button to access the options menu.
2. Select **PUMP DETAILS**.
3. Review the information and then press the **QUIT** softkey.





Note: The following information will be displayed:

- UNIT REFERENCE An identifier configured in Technician Mode by qualified technical personnel.
- SN The Serial Number of the pump
- S/W Software version of the pump

Add Drug

This option allows the user to add a drug whilst the pump is running a ml/h infusion.







Note: This option will not be available when operating the Alaris CC Syringe Pump or the Alaris CC Guardrails Syringe Pump in semi dedicated mode and using an extension set without pressure disc.

1. Press the  button to access the options menu.
2. Select **ADD DRUG** option using the   keys and press the **OK** softkey.
3. Select from Drug from the displayed list using the   keys, press **OK** to confirm.



NOTE: Drugs are configured via Alaris Plus Editor software based on the units available (time / weight based):

- **Gram base:** ng, mcg/ μ g, mg and g
- **Unit base:** mU/mUnits, U/Units and kU/kUnits
- **mmol base:** mmol
- **Volume base:** ml (**Warning: If a running ml/h infusion is promoted to a drug/fluid with dosing unit of ml, from the drug library using the Add Drug functionality, the newly promoted drug/fluid will not contain any predefined soft or hard limits.**)

4. Select drug name using the   keys, press **OK** to confirm.
5. Select concentration using the   keys, press **OK** to confirm, if applicable.
6. Select patient weight using the   keys, press **OK** to confirm, if applicable.
7. Confirm drug, overriding Guardrails soft limits*, as appropriate.

* **Guardrails**

Adjust Alarm Volume

To change the alarm volume, if enabled.

1. Press the  button to access the options menu.
2. Select **ADJUST ALARM VOLUME**.

Note: The pump will beep at the selected alarm volume setting. The user must assess whether the alarm volume setting is loud enough for the intended operating environment, and adjust appropriately.

3. Select alarm volume required and press the **OK** softkey.

Profile Filter



Guardrails

Configure the profiles to be enabled or disabled in the list of selectable profiles, if enabled.

1. Stop the infusion. Press the  button to access the options menu.
2. Select **PROFILE FILTER**.
3. Select Profile(s) required to change and press the **MODIFY** softkey.
4. Press the **OK** softkey to confirm.

Standby

This option allows the pump to be placed on standby mode, if enabled.

1. Stop the infusion. Press the  button to access the options menu.
2. Select **STANDBY** using the   keys, press the **OK** softkey to confirm.
3. Select **CANCEL** to return to main display.

Pressure Features

Auto Set Pressure (If enabled)

If the Auto Set Pressure Option is enabled then the pump *automatically* adjusts the pressure occlusion limit.



After 15 minutes of infusion the pump *automatically* adjusts the occlusion pressure limit to XX mmHg above the average infusion pressure, taken from the average of the last five minutes of infusion.

Note: XX is the **AUTO OFFSET** pressure and is determined by the user. This adjustment, **AUTO OFFSET** value 15-100mmHg, is configurable by profile within the data set. At pressures up to 100mmHg the **AUTO OFFSET** value is added. For pressures above 100mmHg the alarm level is set to whatever the **AUTO OFFSET** value is as a percentage above the average infusion pressure up to the maximum pressure defined within the data set.

Pressure Level with pressure set fitted

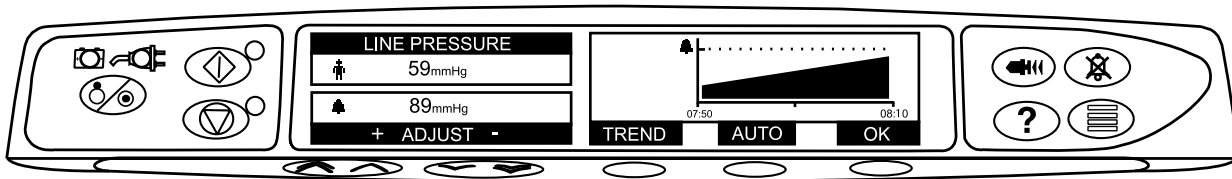

1. To check and adjust the pressure level press the  button. The display will change to show a 20 minute pressure trend graph displaying the pressure alarm level and the current pressure level.

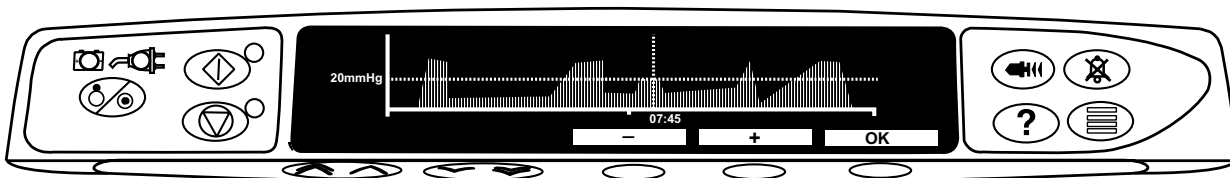

2. Press the   keys to increase or decrease the pressure alarm level. The new level will be indicated on the display.
3. The **AUTO** Pressure feature may be used when a stable pressure has been achieved over a short period of infusion. If **AUTO** Pressure has been enabled the automatic pressure alarm level is calculated and set by pressing the **AUTO** softkey.
4. Press the **TREND** softkey to view the pressure trend of the previous 12 hours. The pressure trend can be viewed at 15 minute intervals by using the +/- softkeys. The pressure trend graph displays the pressure at a given time.
5. Press the **OK** softkey to exit the pressure screen.



Pressure Level*

1. To check and adjust the pressure level press the  button. A bar graph will be displayed showing the pressure alarm level and the current pressure level.
2. Press the   keys to increase or decrease the alarm level. The new level will be indicated on the display.
3. Press **OK** to exit the screen.





The interpretation of the pressure readings and occlusion alarms are the responsibility of the clinician and should include the clinical context in which the pump is being used.

*  without pressure set fitted (not applicable when Fully Dedicated)





Alarms and Warnings



Alarms are indicated by a combination of an audible alarm, flashing alarm indicator and a descriptive message in the display, except prompts which only have an audible alarm and message. The infusion will stop for all alarms that show a red alarm indicator.

1. First press the  button to silence the alarm for a maximum of 2 minutes*, then check the display for an alarm message. Press **CANCEL** to cancel the alarm message.
2. If the infusion has stopped, rectify the cause of the alarm then press the  button to resume the infusion.

 **If the pump initiates a safety processor alarm condition (an audible high pitched continuous shrill accompanied with a red alarm indicator) and there is no error message displayed on the pump, remove the pump from service for examination by a qualified service engineer.**









 **Infusion will stop for all alarms that have a Red (high priority) alarm indicator.**

Display	Alarm Priority	Alarm Indicator	Description and Troubleshooting Guide
DRIVE DISENGAGED	High	Red	The drive system has been disengaged during operation. Check the finger grips and the position of the syringe.
OCCCLUSION	High	Red	Excessive pressure measured at the syringe plunger exceeding the alarm limit. Identify and remove the cause of the blockage in the drive, syringe, or administration system before restarting the infusion.
LINE OCCCLUSION 	High	Red	Excessive pressure measured in the extension set at the pressure sensing disc exceeding the alarm limit. Identify and remove the cause of the blockage in the drive, syringe, patient access site, or administration system before restarting the infusion.
CHECK SYRINGE	High	Red	<p>Incorrect size of syringe has been fitted, the syringe has not been positioned correctly or has been disturbed during operation. Check the syringe location and the position.</p> <p>A CHECK SYRINGE alarm may indicate the incorrect size of syringe has been fitted; the syringe has not been positioned correctly, or has been disturbed during operation, for example, the user opens the syringe clamp, or if the syringe plunger loses contact with the plunger button.</p> <p>If there is no identifiable cause for the CHECK SYRINGE alarm(s) then the pump should be removed from clinical use and examined by Qualified Service Personnel in accordance with the Alaris Syringe Pump Technical Service Manual.</p>
PRESSURE DISC OUT 	High	Red	The pressure disc has been removed from the pressure transducer during the infusion. Replace the pressure disc then restart the infusion.
BATTERY LOW	Medium	Amber	Battery charge low with 30 minutes operation remaining. Reconnect to the AC power supply to charge the internal battery and continue operation. If action is not taken the battery indicator will flash for 30 minutes followed by a continuous audible alarm, red alarm indicator and message BATTERY EMPTY displayed, indicating that the battery is too low to operate the pump.
BATTERY EMPTY	High	Red	The internal battery is too low to operate the pump. Immediately connect the pump to the AC power supply and cycle the power to resume operation.
NEAR END OF INFUSION	Medium	Amber	The pump is nearing the end of the infusion. This value can be configured.
END OF INFUSION	High	Red	The pump has reached the end of the infusion and the pump has stopped infusing. A pre-set volume will remain in the syringe to minimise the risk of the infusion of air bubbles into the set. This value can be configured.
END OF INFUSION	Medium	Amber	The pump has reached the end of the infusion and the pump continues to infuse at KVO or set rate if lower.
TITRATION NOT CONFIRMED	Medium	Amber	The infusion rate has been changed, but has not been confirmed and 2 minutes has expired without any operation. Press the  button to silence the alarm, then press the CANCEL softkey to clear this message and silence the alarm. Check infusion rate and confirm by pressing the  button or press the  button to revert to the previous rate. (This alarm only occurs if rate titration is enabled). Pressing QUIT will cancel the titration and keep the original rate.
VTBI DONE	High	Red	The pre-set Volume To Be Infused is complete and the pump has stopped infusing.
VTBI DONE	Medium	Amber	The pre-set Volume To Be Infused is complete and the pump continues to infuse at set rate or at KVO rate.

Display	Alarm Priority	Alarm Indicator	Description and Troubleshooting Guide
AC POWER FAIL	Medium	Amber	AC Power has been disconnected and the pump is operating on battery power, if this occurs when the pump is infusing the message INFUSION CONTINUES will be displayed. Reconnect AC power supply or press the  button to silence the alarm and continue with battery operation. The alarm will automatically cancel if the AC power supply is reconnected.
Error Code and Message	High	Red	The alarm system has detected an internal malfunction. Note the malfunction code. Remove pump from service for examination by a qualified service engineer.
ADD DRUG NOT COMPLETE	Medium	Amber	The ADD DRUG operation has not been completed. Press CANCEL softkey and complete ADD DRUG option.
ATTENTION (with “3 Beeps”)	Medium	Amber	Three beeps will sound if the pump has been left ON for more than 2 minutes* (referred to as CALLBACK in the log) without starting the operation. Press the  button to silence the alarm for a further 2 minutes*. For extended callback press and hold down the  button and wait for 3 beeps in succession, this will put the pump on standby for 15 minutes.

*Configurable option.

Prompts

Display	Icon	Description and Troubleshooting Guide
DOSE WOULD EXCEED*		The dose rate has been set to a value which exceeds a Guardrails Soft Alert. Check infusion setting, to continue with infusion at set rate confirm OVERRIDE LIMIT by pressing the YES softkey. If OVERRIDE LIMIT is not required press the NO softkey and adjust rate below Guardrails Soft Alert.
DOSE UNDER*		The dose rate has been set to a value which is under a Guardrails Soft Alert. Check infusion setting, to continue with infusion at set rate confirm OVERRIDE LIMIT by pressing the YES softkey. If OVERRIDE LIMIT is not required press the NO softkey and adjust rate above Guardrails Soft Alert.
DOSE NOT PERMITTED		The dose rate has been set above a Hard Limit. Check infusion setting and adjust rate to appropriate required rate.
BOLUS DOSE OVER*		The bolus dose has been set to a value which exceeds a Guardrails Soft Alert. Check the bolus setting, to continue with the bolus confirm OVERRIDE LIMIT by pressing the YES softkey. If OVERRIDE LIMIT is not required press the NO softkey and adjust dose below Guardrails Soft Alert.
BOLUS DOSE UNDER*		The bolus dose has been set to a value which is under a Guardrails Soft Alert. Check the bolus setting, to continue with the bolus confirm OVERRIDE LIMIT by pressing the YES softkey. If OVERRIDE LIMIT is not required press the NO softkey and adjust dose above Guardrails Soft Alert.
BOLUS DOSE NOT PERMITTED		The bolus dose has been set above a Hard Limit. Check bolus setting and adjust to appropriate required dose.
CONCENTRATION NOT PERMITTED		The drug concentration has been set above or below a Hard Limit. Check the amount and total volume and adjust to give the appropriate required concentration.
WEIGHT OUTSIDE LIMIT*		The patient weight has been set to a value which exceeds or is under a Guardrails Soft Alert. Check the weight setting, to continue confirm OVERRIDE LIMIT by pressing the YES softkey. If OVERRIDE LIMIT is not required press the NO softkey and adjust the value within the limits.
RATE NOT PERMITTED		The infusion rate has been set above a Hard Limit. Check infusion setting and adjust to appropriate required rate.

* **Guardrails**

Configured Options

This section comprises of a list of options which are configurable. Some can be entered via the pump configuration menu (available in Technician Mode) and others through the Alaris Editor Software.





Enter the access code on the pump for Configured Options, see the *Technical Service Manual* for details.



Access codes should only be entered by qualified technical personnel.





Use Alaris Editor to configure general options, drug library and units enabled for each profile and to configure Syringe Brands and Models to be enabled.

Clock Set

1. Select **CLOCK SET** from the Configured Options menu using the   keys and press the **OK** softkey.
2. Use the   keys to adjust the date displayed, pressing the **NEXT** softkey to access the next field.
3. When the correct time and date are displayed press the **OK** softkey to return to the Configured Options menu.





Language

This option is used to set the language of messages shown on the pump display.



1. Select **LANGUAGE** from the Configured Options menu using the   keys and press the **OK** softkey.
2. Use the   keys to select the language.
3. When the desired language has been selected press **SELECT** softkey to return to the Configured Options menu.

Contrast

This option is used to set the contrast on the pump display.

1. Select **CONTRAST** from the Configured Options menu using the   keys and press the **OK** softkey.
2. Use the   keys to select a contrast ratio value. The contrast of the display will change when scrolling through the numbers.
3. When the desired value has been reached press the **OK** softkey to return to the Configured Options menu.

General Options

1. Select **GENERAL OPTIONS** from the Configured Options menu using the   keys and press the **OK** softkey.
2. Select the option required to enable/disable or adjust and press the **MODIFY** softkey.
3. When all the required modifications have been carried out press the **QUIT** softkey.
4. Either select the next configuration option from the menu or turn the pump **OFF**, returning it to operation as required.

NURSE CALL FITTED	Enables Nurse Call (hardware option).
NURSE CALL INVERT	When enabled, the nurse call output is inverted.
RS232 SELECTED	Sets the pump's communications to use RS232 (hardware option). The NURSE CALL FITTED option must be enabled to allow RS232 to be enabled.

Alaris Editor Software Profile Configuration

The following options are only configurable via the Alaris Editor Software (PC based), see Alaris Editor Directions For Use for details on how to configure Profile Configurations.







Data Set Configuration Settings

Hospital Name	Configure the name of the facility to be displayed on the pump.	
Profile Filter	Controls whether the user is able to filter which profiles will be available on the pump.	
Guardrails		
Unit Display	Microgram	The text used to display microgram, either mcg or µg.
	Unit	The text used to display Units, either mU, U and kU or mUnit, Unit and kUnit.

General Pump Configurations

AC Fail	The AC Power Failure Alarm can be set to sound or be silent if the AC power is removed.
Audio Volume	The audio alarm volume of the pump (high, medium or low).
Audio Volume Adjustable	Sets whether the user is able to adjust the audio volume setting.
Auto Night Mode	Main Display (Backlight) dims between hours 21:00 and 06:00.
Auto Save	Feature to retain previous settings when pump is switched on.
Battery Icon	Indicator displaying the remaining estimated battery capacity.
Callback Time	Adjusts the length of time before the pump sounds the call back alarm.
Drug Override Mode	Always - Confirmation of setting will be required for any changes made to the dose rate that are outside of the Guardrails Soft Alerts Smart - Confirmation of setting will be required on first dose rate set outside of the Guardrails Soft Alert. Any subsequent changes will not require confirmation until after the dose rate has been confirmed inside the Guardrails Soft Alert limits. Additionally any changes in dose rate from above a Soft Alert Max to below a Soft Alert Min or from below a Soft Alert Min to above a Soft Alert Max will also need to be confirmed.
Guardrails	
Event Log	The event log can be set to be displayed or not on main display. Events are still recorded in the log.
Pressure Display	Sets whether the Pressure Information is available on the display.
Quiet Mode	Mode to silence key press tones and power down sequence.
Rate Titration	Feature to adjust the infusion rate while the pump is infusing, without putting the pump on hold.
Rate Lock	Anti-tamper feature which prevents rate changes, bolus operations and powering pump down.
Standby Mode	Sets whether the Standby Mode is available on the pump.
VTBI Clear Rate	Infusion rate will be set to zero when VTBI has been completed.
Weight Default	The default patient weight in kg.
Weight Soft Minimum	The minimum patient weight in kg. This is a Guardrails Soft Alert and can be overridden.
Guardrails	
Weight Soft Maximum	The maximum patient weight in kg. This is a Guardrails Soft Alert and can be overridden.
Guardrails	

General Syringe Pump Configurations

Back Off	An automatic feature which is activated following an occlusion. The pump action reverses and pumps backwards to release the pressure which has built up in the infusion system, this minimises the post occlusion bolus.
Display Syringe Brand	Sets whether the syringe brand and size is shown while pump is infusing.
Manual Bolus	Bolus delivered by manually moving the plunger mechanism during an infusion or while on hold. Volume infused displayed will be increased accordingly.
Bolus Mode	Bolus feature can be set to one of the following options: <ul style="list-style-type: none"> • Disabled • Hands-On only • Hands-Free and Hands-On
Bolus Rate Default	The default value for bolus rates.
Bolus Rate Max	The maximum value for bolus rate.
Bolus Volume Max	The maximum permissible bolus volume.
Infusion Rate Max	The maximum value for infusion rate.
Near End of Infusion Point	Sets the Near End Of Infusion warning time, as time left to End Of Infusion.
End of Infusion	Sets the End Of Infusion point, as a percentage of syringe volume.
KVO at EOI	Sets whether the Keep Vein Open (KVO) at End Of Infusion (EOI) is available.
KVO Rate	Sets the Keep Vein Open (KVO) rate at which the pump will operate when End of Infusion (EOI) is reached.
Purge Syringe	Feature which prompts the user to purge the extension set prior to the start of the infusion.
Purge Rate	The rate used during purge operation.
Purge Volume Max	The maximum permissible purge volume.
VTBI Max	The maximum value for Volume To Be Infused (VTBI).
Pressure Maximum 	The maximum occlusion pressure alarm value that can be selected during an infusion.
Occlusion Alarm Pressure 	The default occlusion pressure alarm value that can be selected during an infusion.
Auto Pressure 	Feature to set the occlusion pressure alarm level to an amount (mmHg) above the current in-line pressure, using a single key press.
Auto Set Pressure 	Automatic feature to set the occlusion pressure alarm level to an amount (mmHg) above the current in-line pressure, 15 minutes after starting the infusion.
Auto Offset 	The automatic offset value in mmHg used by auto pressure and auto set pressure.
Pressure Maximum 	The maximum occlusion pressure alarm level that can be selected during an infusion.
Occlusion Alarm Pressure 	The default occlusion pressure alarm level that can be selected during an infusion.



The approved data set contains configurable option values per profile.



Dosing Only Units

The following dose rate units can be configured for use in Dosing Only mode. Checking the **All** checkbox will select all of the listed units.

Type	Unit	Default Value	Unit	Default Value	Unit	Default Value	Unit	Default Value
Gram Based	ng/min	Disabled	ng/kg/min	Enabled	ng/h	Disabled	ng/kg/h	Disabled
	ng/24h	Disabled	ng/kg/24h	Disabled	µg/min	Enabled	µg/kg/min	Enabled
	µg/h	Enabled	µg/kg/h	Enabled	µg/24h	Disabled	µg/kg/24h	Disabled
	mg/min	Disabled	mg/kg/min	Enabled	mg/h	Enabled	mg/kg/h	Enabled
	mg/24h	Disabled	mg/kg/24h	Disabled	g/min	Disabled	g/kg/min	Disabled
	g/h	Enabled	g/kg/h	Disabled	g/24h	Disabled	g/kg/24h	Disabled
Unit Based	mU/min	Disabled	mU/kg/min	Disabled	mU/h	Disabled	mU/kg/h	Disabled
	mU/24h	Disabled	mU/kg/24h	Disabled	U/min	Disabled	U/kg/min	Disabled
	U/h	Enabled	U/kg/h	Enabled	U/24h	Disabled	U/kg/24h	Disabled
	kU/min	Disabled	kU/kg/min	Disabled	kU/h	Disabled	kU/kg/h	Disabled
	kU/24h	Disabled	kU/kg/24h	Disabled				
mmol Based	mmol/min	Disabled	mmol/kg/min	Enabled	mmol/h	Enabled	mmol/kg/h	Enabled
	mmol/24h	Disabled	mmol/kg/24h	Disabled				
Volume Based	ml/min	Disabled	ml/kg/min	Disabled	ml/h	Always Enabled	ml/kg/h	Disabled
	ml/24h	Disabled	ml/kg/24h	Disabled				

Alaris Editor Software Profile Drug library

The following drug parameters are only configurable via the Alaris Editor Software, see *Alaris Editor Directions For Use* for details on how to configure Profile Drug Library, and are used when the pump is operated with a drug name selected.

Concentration Units		The unit for concentration parameters
Concentration Limits (Min and Max)		These define the range over which the drug concentration can be modified during programming of the pump.
Continuous Dose Rate -	Units	The continuous dose rate units. Can be based on patient weight.
	Soft Min*	The continuous dose rate value below which override confirmation is required.
	Default	The default continuous dose rate offered when the drug is selected.
	Soft Max*	The continuous dose rate value above which override confirmation is required.
	Hard Max	The maximum allowed continuous dose rate.
Bolus Mode		Bolus feature can be set to one of the following options: <ul style="list-style-type: none"> • Disabled • Hands-On only • Hands-Free and Hands-On
Bolus Dose -	Units	The bolus dose units. Can be based on patient weight.
	Soft Min* (Hands-Free only)	The bolus dose value below which override confirmation is required.
	Default (Hands-Free only)	The default bolus dose offered.
	Soft Max* (Hands-Free only)	The bolus dose value above which override confirmation is required.
	Hard Max	The maximum allowed bolus dose.
Bolus Rate -	Default	The default value for bolus rate in ml/h.
Occlusion Alarm Pressure 		The default occlusion alarm pressure.
Occlusion Alarm Pressure 		The default occlusion alarm pressure.

* **Guardrails**

Profile Syringe Library

The Profile Syringe Library is created from the predefined Master Syringe Library.

Check the boxes of the syringes to be included in the profile. Checking the **All Syringes** checkbox under **Operations** selects all the syringes.

For Syringe brands and sizes available see 'Recognised Syringes' section.

Note: It is recommended that only syringe types and sizes used in the care area are selected.

Specifications

Infusion Specifications

Maximum infusion rate can be set as part of the configuration.

0.1ml/h - 150ml/h	5ml syringes
0.1ml/h - 300ml/h	10ml syringes
0.1ml/h - 600ml/h	20ml syringes
0.1ml/h - 900ml/h	30ml syringes
0.1ml/h - 1200ml/h	50ml syringes

Infusion Rate Increments:

Rate Range (ml/h)	Single Chevron Key Increments (ml/h)	Double Chevron Key Increments (ml/h)
0.10 to 9.99	0.01	0.10
10.0 to 99.9	0.1	1.0
100 to 999	1	10
1000 to 1200	10	100

The Volume Infused range is 0.0ml - 9990ml.

Bolus Specifications

Maximum Bolus rates can be set as part of the configuration. Bolus rates are user adjustable, in increments of 10ml/h.

10 ml/h - 150ml/h	5ml syringes
10 ml/h - 300ml/h	10ml syringes
10 ml/h - 600ml/h	20ml syringes
10 ml/h - 900ml/h	30ml syringes
10 ml/h - 1200ml/h	50ml syringes

The bolus volume limit can be set as part of the configuration.

- Minimum: 0.1ml; maximum 25.0ml
- Increments of 0.1ml; default 5.0ml

During BOLUS the pressure limit alarms are temporarily increased to their maximum level.

Bolus Volume Accuracy*

CC	Bolus Volume	Typical	Typical Maximum	Typical Minimum	Pump Specification
	0.1ml	1.7%	5.1%	-2.5%	± 10%
	25ml	0.1%	0.5%	-0.6%	± 5%

GH	Bolus Volume	Typical	Typical Maximum	Typical Minimum	Pump Specification
	0.1ml	1.9%	6.2%	-7.3%	± 10%
	25ml	0.2%	0.5%	-0.1%	± 5%

* - Using BD Plastipak 50ml syringe at 5ml/h under normal conditions (95% confidence / 95% of pumps).

Critical Volume

The bolus which can occur in the event of a single internal fault condition with a 50 ml syringe is : Maximum Overinfusion - 0.87ml

Purge Specifications

The purge rate is limited to the maximum rate for the syringe and can be set as part of the configuration.

100ml/h - 500ml/h.

The purge volume range is 0.5ml - 5ml.

During PURGE the pressure limit alarms are temporarily increased to their maximum level.

Keep Vein Open (KVO) Rate

0.1 ml/h - 2.5ml/h.

End Of Syringe Rate

Stop, KVO (0.1ml/h to 2.5ml/h), or set rate if lower than KVO.

Volume To Be Infused (VTBI)

0.10ml - 1000ml, 1min - 24h

VTBI Complete Rate

Stop, KVO (0.1ml/h to 2.5ml/h), set rate if lower than KVO or continue at set rate.

Near End Of Infusion Alarm

1min - 15min to end of infusion, or 10% of syringe volume, whichever is smaller.

End Of Infusion (EOI) Alarm

0.1% - 5% of syringe volume

Maximum Pumping Pressure Limit

Highest alarm level 1000mmHg (nominal at L-10)

Occlusion Accuracy without pressure set (% of full scale)*

	Pressure mmHg			
	L-0 approx. 50mmHg	L-3 approx. 300mmHg	L-5 approx. 500mmHg	L-10 approx. 1000mmHg
Temp. 23°C	±18%	±21%	±23%	±28%

Occlusion Accuracy with pressure set (% of full scale)* 

	Pressure mmHg			
	0	25	500	1000
Temp. 23°C	±2%	±4%	±5%	±6%
Temp. 5°C-40°C	±4%	±7%	±7%	±10%

* - Using most common 50ml syringes under normal conditions (95% confidence / 95% of pumps).

System Accuracy

Volumetric Mean +/- 2% for rates ≥ 1ml/h (nominal).

- Derating - Temperature +/- 0.5% (5 - 40°C), High Rates +/-2.0% (rates > syringe volume/h eg. >50ml/h in a 50ml syringe.)



System accuracy is +/-2% typical by volume as measured using the trumpet curve test method defined in EN/IEC60601-2-24 at rates of 1.0ml/h (23°C) and above when the pump is used with the recommended syringes. Caution: Infusion volume accuracy may be compromised at rates below 1.0ml/h. Differences in factors such as size and plunger force in recognised syringes can cause variations in accuracy and trumpet curves. See also 'trumpet curves' section in this manual.

Electrical Classification

Class I product. Continuous Mode Operation, Transportable

Data set Specification

A maximum of 30 profiles can be set with a maximum of 100 drugs per profile, with only one profile permitted to be uploaded to a Non-Guardrails pump at a time. See Alaris Editor Software DFU for more details.

Battery Specifications

Rechargeable sealed NiMH. Automatically charges when the pump is connected to AC power.

Mean Time To Power Down from fully charged @ 5ml/h and 23°C ± 2°C under normal conditions is 6 hours*

*95% lower confidence interval of 5 hours 50 minutes

Charging takes 2½ hours from discharge to 90% charge.

Memory Retention

The electronic memory of the pump will be retained for at least 6 months when not powered up.

Fuse Type

2 x T1.25L250V

AC Power Supply

115 - 230VAC, 50 - 60Hz, 30VA (under maximum charging conditions) 10VA (nominal).

Dimensions



335 mm (w) x 121 mm (h) x 200 mm (d).



310 mm (w) x 121 mm (h) x 200 mm (d).

Weight (excluding power cable)

Pump: 2.4 kg.



Pump with lock box: 3.2 kg

Protection against fluid ingress

IP32 - Protected against direct sprays of water up to 15° from vertical and protected against solid objects greater than 2.5mm.

Note: IP33 applies if mains retainer kit, part number 1000SP01294, is fitted.

Alarm Conditions

Drive Disengaged	Occlusion	Attention (Nurse Callback)
Check Syringe	Battery Low	Titration not confirmed
Line Occlusion 	Battery Empty	VTBI Done
Near End Of Infusion	End of Infusion	AC Power Fail
Internal Malfunction	Pressure Disc Out 	Dose Under
Dose Would Exceed	Dose not Permitted	Bolus Dose not Permitted
Bolus Dose Under	Bolus Dose Over	Rate not Permitted
Concentration not Permitted	Weight Outside Limit	Add Drug Not Complete

Environmental Specifications

Operating Temperature	0°C - +40°C
Operating Relative Humidity	20% - 90%
Operating Atmospheric Pressure	700hPa - 1060hPa
Transport & Storage Temperature	-30°C - +50°C
Transport & Storage Relative Humidity	10% - 95%
Transport & Storage Atmospheric Pressure	500hPa - 1060hPa

Electrical/Mechanical Safety

Complies with EN/IEC60601-1 and EN/IEC60601-2-24.

Potential Equalisation Conductor

The function of the Potential Equalisation Connector (Conductor) is to provide a direct connection between the pump and the potential equalisation busbar of the electrical installation. To use the Potential Equalisation Connector, connect the Potential Equalisation Connector on the pump to the potential equalisation busbar of the electrical installation.

EMC

Complies with EN/IEC60601-1-2 and EN/IEC60601-2-24.

Recognised Syringes

The pump is calibrated and labelled for use with single-use disposable Luer lock syringes. Only use the size and type of syringe specified on the pump display. The full list of permitted syringe models is dependent on the software version of the pump.

	5ml	10ml	20ml	30ml	50ml
IVAC®					✓
AstraZeneca*					✓
B Braun Omnifix*	✓	✓	✓	✓	✓
B Braun Perfusor*			✓		✓
BD Perfusion*					✓
BD Plastipak*	✓	✓	✓	✓	✓
BD Precise*			✓		✓
Codan*		✓	✓	✓	✓
Codan Perfusion*					✓
Fresenius Injectomat*		✓			✓
Monoject ^{2*}	✓	✓	✓	✓	✓
Pentaferte*	✓	✓	✓		✓
Rapiject ^{1*}					✓
Terumo*	✓	✓	✓	✓	✓

1 - The Rapiject 50ml syringe is a specialised syringe with a large diameter barrel. To provide protection against accidental dislodging always ensure the extension set is secured using the extension set hook - see 'Loading and Confirming a Syringe' section.

2 - ☰ TYCO / Healthcare KENDALL - MONOJECT.



To minimise the risk of incorrect confirmation of the syringe type it is recommended that only syringe types available in the hospital are configured on the pump.



CareFusion has characterized a range of syringes as identified in the 'Recognised Syringes' table. CareFusion cannot guarantee the continued system accuracy of these recognised syringes* as the manufacturer may change syringe specification significant to system accuracy without prior notification.

Subject to the above, BD branded luer lock syringes can be confirmed as BD Plastipak syringes due to there being no significant variance in dimensions.

In no event shall CareFusion be liable for any damages of any kind or nature, including without limitation, direct or indirect, special, consequential, or incidental damages arising from, or in connection with the use of syringes not listed in the 'Recognised Syringes' table.

Associated Products

The Alaris Gateway Workstation

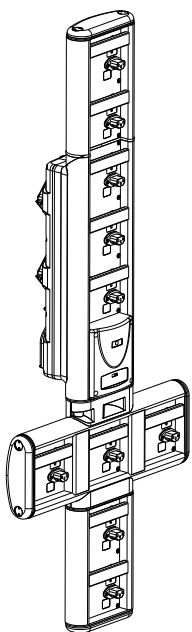

Product SKU	80203UNS0y-xx
Supply Voltage	115-230VAC, ~50-60Hz
Electrical Rating	460VA (Maximum)
Protection Against Electrical Shock	Class 1
Classification	Continuous Operation
Supply to pump	115-230V, ~50-60Hz, 60VA

The Alaris DS Docking Station

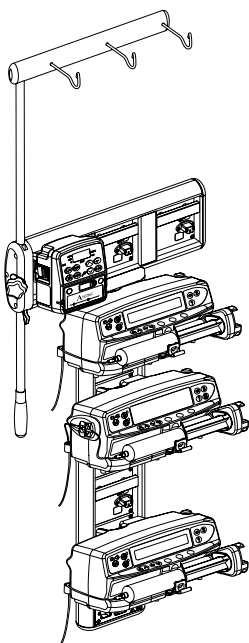

Product SKU	80283UNS00-xx
Supply Voltage	230VAC, 50 or 60Hz
Electrical Rating	500VA (nominal)
Protection Against Electrical Shock	Class 1
Classification	Continuous Operation
Supply to pump	20VA max 230V 50-60Hz

y = Connectivity option - 1, 2 or 3

xx = Configuration

Compatible Extension Sets

The pump uses standard, single-use, disposable extension sets and syringes with Luer lock connectors. The user is responsible for verifying the suitability of a product used, if it is not recommended by CareFusion.

Standard Sets

G40015 Standard PVC Syringe Extension Set (150 cm).
Priming Volume: 2.6ml

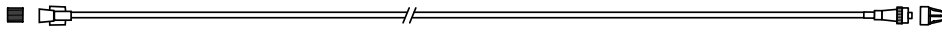

G40020B Standard PVC Syringe Extension Set (200 cm).
Priming Volume: 1.5ml

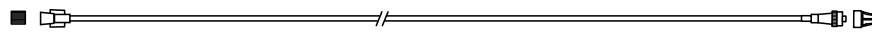

G402EP Extension set, Luer lock connectors. Kink resistant DEHP free PVC yellow striped tubing. Bore 1mm. (200cm)
Priming volume 1.6ml.



G30402M  Standard PVC Syringe Extension Set with occlusion sensing disc. (200 cm).
Priming Volume: 1.5ml



G302EP  Extension set, with pressure sensing disc, Luer lock connectors. Kink resistant DEHP free PVC yellow striped tubing. Bore 0.9mm. Length 200cm. Priming volume 1.5ml



Low Sorbing Sets

G40615 Polyethylene Syringe Extension Set (150 cm).
Priming Volume: 1.5ml



G40620 Polyethylene Syringe Extension Set (200 cm).
Priming Volume: 2ml



G30303M  Polyethylene Syringe Extension Set with occlusion sensing disc. (200 cm).
Priming Volume: 1.5ml

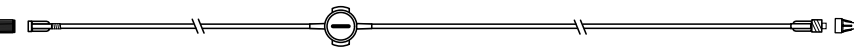

G30453M  Opaque White PVC low sorbing Syringe Extension Set with occlusion sensing disc. (200 cm).
Priming Volume: 1.5ml



G30302M  Polyethylene Lined Syringe Extension Set with occlusion sensing disc and clamp. (200 cm).
Priming Volume: 1.6ml

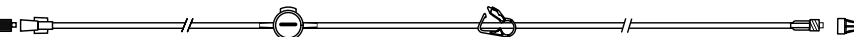

G40720 Polyethylene Lined Syringe Extension Set with clamp. (200 cm).
Priming Volume: 1.5ml

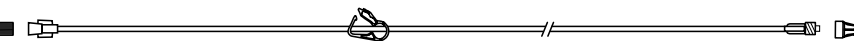

04105010509 Polyethylene Syringe Extension Set (100 cm).
Priming Volume: 1ml

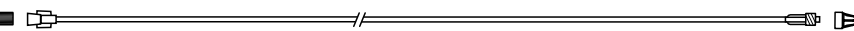



- **New sets are continuously being developed for our customers. Please contact your local CareFusion representative for availability.**
- **It is recommended that extension sets are changed in accordance with the Directions for Use. Carefully read the Directions For Use supplied with the extension set prior to use.**

Please note these drawings are not to scale

The pump uses standard, single-use, disposable extension sets and syringes with Luer lock connectors. The user is responsible for verifying the suitability of a product used, if it is not recommended by CareFusion.

Light Protected Sets

G40215	Amber PE Syringe Extension Set (150 cm). Priming Volume: 1.2ml	
G40320	White PVC Syringe Extension Set (200 cm). Priming Volume: 3.6ml	
G30653M	Opaque White PVC Syringe Extension Set with occlusion sensing disc. (200 cm). Priming Volume: 1.5ml	

Patient Controlled Analgesia (PCA) Sets

30822	PVC Syringe Extension Set with clamp (152 cm). Priming Volume: 0.5ml	
30832	PVC 'Y' Syringe Extension Set with back check valve and 2 clamps (178 cm). Priming Volume: 1.5ml	
30842E	PVC Syringe Extension Set with back check valve, SmartSite™ Needle-Free Valve Port and clamp (30 cm). Priming Volume: 1.4ml	
30852	PVC 'Y' Syringe Extension Set with anti-siphon valve, back check valve and 2 clamps (183 cm). Priming Volume: 1.8ml	
30862	PVC Syringe Extension Set with anti-siphon valve and clamp (156 cm). Priming Volume: 0.6ml	
04102215162	PVC Syringe Extension Set with rotating luer. (150 cm). Priming Volume: 2.9ml	
04100010162	PVC Syringe Extension Set (105 cm). Priming Volume: 7.2ml	

- **New sets are continuously being developed for our customers. Please contact your local CareFusion representative for availability.**
- **It is recommended that extension sets are changed in accordance with the Directions for Use. Carefully read the Directions For Use supplied with the extension set prior to use.**

Please note these drawings are not to scale

Maintenance

Routine Maintenance Procedures

To ensure that this pump remains in good operating condition, it is important to keep it clean and carry out the routine maintenance procedures described below.

Interval	Routine Maintenance Procedure
As per Hospital Policy	Thoroughly clean external surfaces of the pump before and after prolonged period of storage.
Each usage	1. Inspect AC power supply plug and cable for damage.
	2. Inspect case, keypad and plunger for damage.
	3. Check Start up self test operation is correct.
Before the transfer of the pump to a new patient and as required	Clean the pump by wiping over with a lint-free cloth lightly dampened with warm water and a standard disinfectant / detergent solution.



If the pump is dropped, damaged, subjected to excessive moisture or high temperature, immediately take it out of service for examination by a qualified service engineer.

All preventative and corrective maintenance and all such activities shall be performed at a compliant work place in accordance with the information supplied. CareFusion will not be responsible should any of these actions be performed outside the instructions or information supplied by CareFusion. For Preventative and Corrective Maintenance instructions please refer to the Technical Service Manual (TSM).

All preventative and corrective maintenance and all such activities should be performed by a qualified service engineer only, with reference to the TSM.



Please refer to Technical Service Manual for calibration procedures. The units of measurement used in the calibration procedure are standard SI (The International System of Units) units.

Battery Operation

The internal rechargeable battery allows continued operation when the AC power is unavailable, for example during patient transfer or AC power failure. Mean Time To Battery Empty from fully charged @ 5ml/h & 20°C under normal conditions is 6 hours*. From the battery low alarm it will take about 2½ hours to 90% charge when reconnected to the AC power supply, whether the pump is in use or not.

The battery is maintenance free, sealed Nickel Metal Hydride and requires no routine servicing. However, to achieve optimum operation, ensure that the battery is fully recharged after full discharge, before storage, and at regular 3 month intervals during storage.

It is recommended that only a qualified service engineer replaces the battery, only use CareFusion recommended battery. For further information regarding the replacement of batteries refer to the *Technical Service Manual*.

The battery pack used in this Alaris Syringe Pump is manufactured by CareFusion and includes a proprietary PCB (printed circuit board) designed specifically for the Alaris Syringe Pump, and in conjunction with Alaris Syringe Pump software, controls battery use, charge and temperature. Any use of battery packs that are not manufactured by CareFusion in the Alaris Syringe Pump is at your sole risk, and CareFusion does not provide any warranty for or endorsement on any battery packs that are not manufactured by CareFusion. CareFusion's product warranty shall not apply in the event the Alaris Syringe Pump has suffered damage or premature wear, or malfunctions or otherwise operates incorrectly, as a result of use with a battery pack that is not manufactured by CareFusion.

*95% lower confidence interval of 5 hours 50 minutes

Cleaning and Storage

Before the transfer of the pump to a new patient and periodically during the use, clean the pump by wiping over with a lint-free cloth lightly dampened with warm water and a standard disinfectant / detergent solution.

Do not use the following disinfectant types:

- Disinfectants which are known to be corrosive to metals must not be used, these include:
 - NaDcc (such as Presept),
 - Hypochlorites (such as Chlorasol),
 - Aldehydes (such as Cidex),
 - Cationic Surfactants >1% (such as Benzalkonium Chloride),
 - Mixture of Alcohol & Chemicals with Cationic surfactants >1% Chlorohydrocarbons (such as Amberclens).
- Use of Iodine (such as Betadine) will cause surface discoloration.
- Concentrated Isopropyl alcohol based cleaners will degrade plastic parts.

Recommended cleaners are:

Brand	Concentration
Hibiscrub	20% (v/v)
Virkon	1% (w/v)

The following products were tested and are acceptable for use on the Pump if used in accordance with the specified manufacturer's guidelines.

- Warm soapy water
- Mild detergent in water (e.g. Young's Hospec)
- 40% Isopropyl Alcohol in water
- Chlor-Clean
- Clinell Universal Wipes
- Hibiscrub
- Tristel Fuse sachets
- Tristel Trio wipes system
- Tuffie 5 wipe
- Virkon Disinfectant



Before cleaning always switch off and disconnect from the AC power supply. Never allow liquid to enter the casing and avoid excess fluid build up on the pump. Do not use aggressive cleaning agents as these may damage the exterior surface of the pump. Do not steam autoclave, ethylene oxide sterilise or immerse this pump in any fluid.

If the pump has visible cracks or damage to the case do not clean and immediately take it out of service for examination by a qualified service engineer.

Ensure the pressure transducer is free from residues, which may prevent correct operation of the disc detector.

The syringe and extension sets are disposable single use items and should be discarded after use according to their manufacturers' instructions.

If the pump is to be stored for an extended period it should be first cleaned and the internal battery fully charged. Store in a clean, dry atmosphere at room temperature and, if available, employ the original packaging for protection.

Once every 3 months during storage, carry out functional tests as described in the *Technical Service Manual* and ensure that the internal battery is fully charged.

Disposal

Information on Disposal for Users of Waste Electrical & Electronic Equipment

This  symbol on the product and/or accompanying documents means that used electrical and electronic products should not be mixed with household waste.

If you wish to discard electrical and electronic equipment, please contact your CareFusion affiliate office or distributor for further information.

Disposing of this product correctly will help to save valuable resources and prevent any potential negative effects on human health and the environment which could otherwise arise from inappropriate waste handling.

Information on Disposal in Countries outside the European Union

This symbol is only valid in the European Union. The product should be disposed of taking environmental factors into consideration. To ensure no risk or hazard, remove the internal rechargeable battery and the Nickel Metal Hydride battery from the control board and dispose of as outlined by the local country regulations. All other components can be safely disposed of as per local regulations.

Occlusion Pressure Limits

Time to alarm following occlusion is achieved in less than 30 minutes at rates of 1 ml/h and higher by the appropriate selection of occlusion levels.

Use of the dedicated pressure set is recommended for the Alaris CC Syringe Pump and the Alaris CC Guardrails Syringe Pump. Its use permits the occlusion alarm pressure (mmHg) to be set accurately, with a small operating margin between the alarm and normal infusion pressures. When using infusion pumps without a pressure set, line pressures are estimated from pumping force. For this reason the occlusion alarm needs to be set with an operating margin of at least one level between the alarm and normal infusion levels. The ability to set a small operating margin permits short time to alarm and small potential bolus volumes to be achieved. Bolus volumes can be minimised as described in the Alarms and Warnings - Occlusion or by enabling the back off general option.

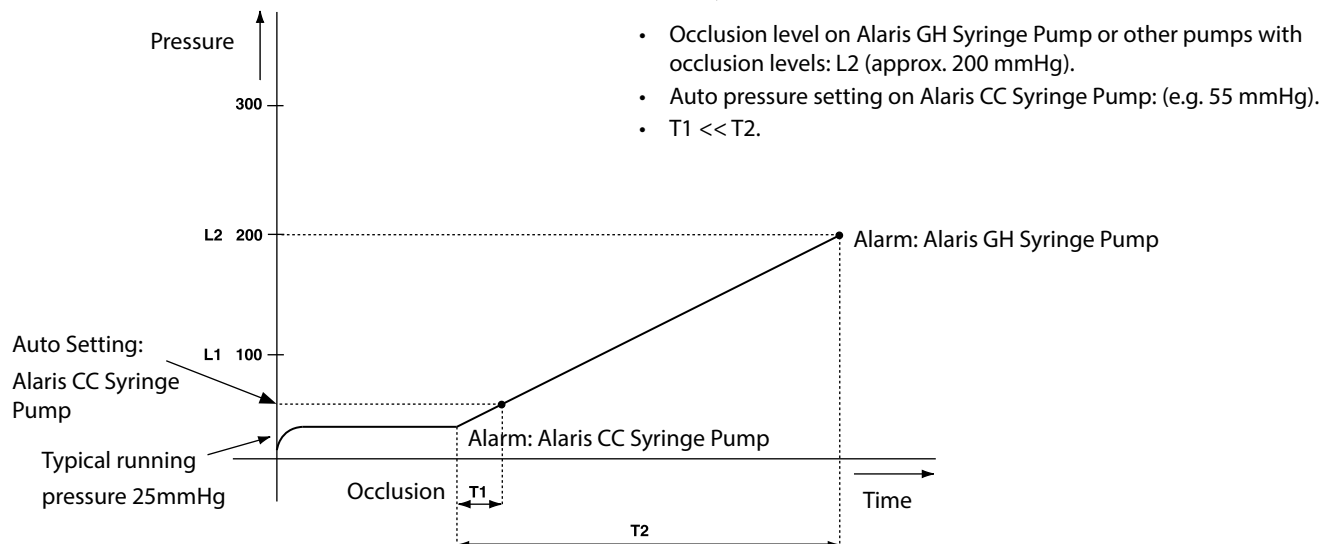

With a Pressure Extension Set fitted, G30402M - Standard disposable extension set



The following graphs show the typical values for time to alarm and bolus volume that can be expected in the event of an occlusion when the BD Plastipak 50 ml syringe is selected with a G30402M extension set with occlusion sensing disc.

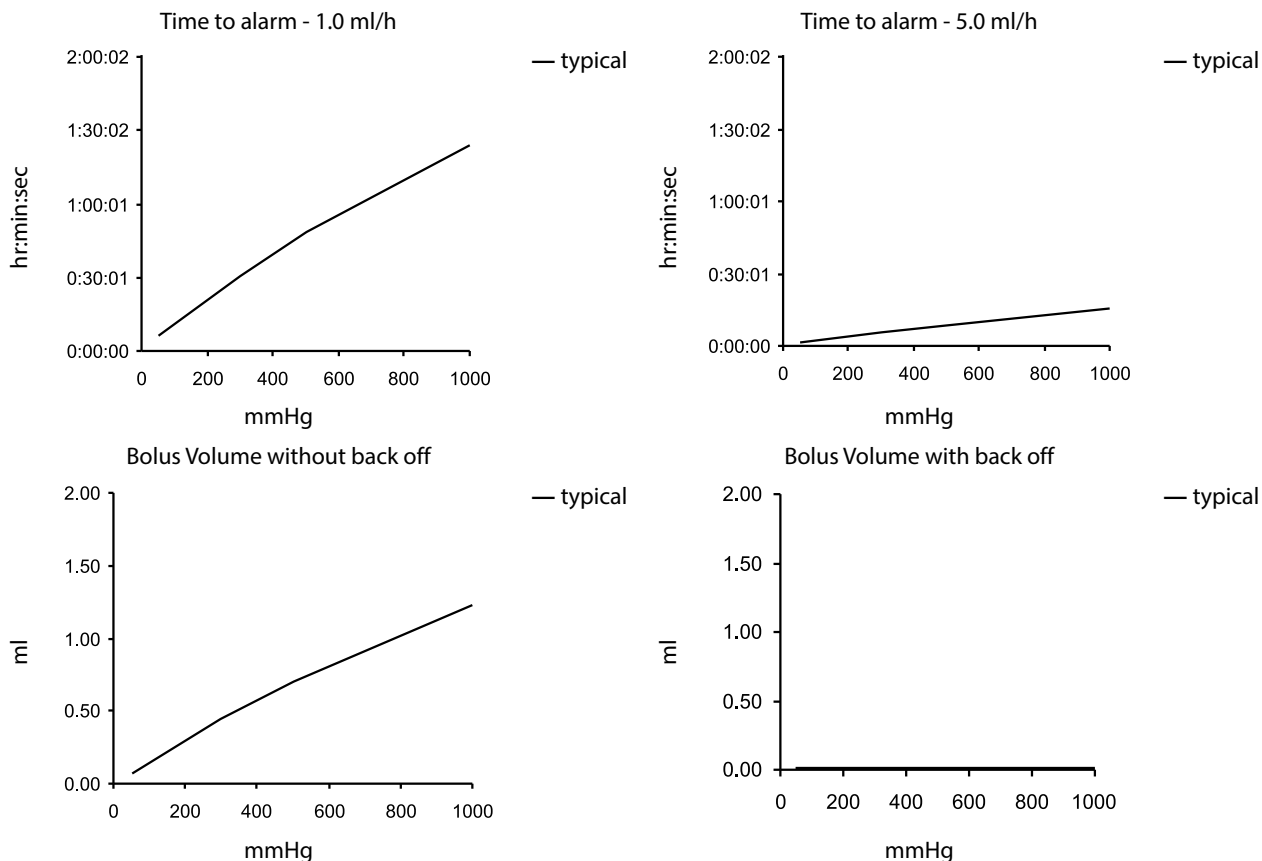

Without a Pressure Extension Set fitted, G40020B - Standard disposable extension set

The following graphs show the typical values for time to alarm and bolus volume that can be expected in the event of an occlusion when the BD Plastipak 50 ml syringe is selected with a G40020B standard extension set.

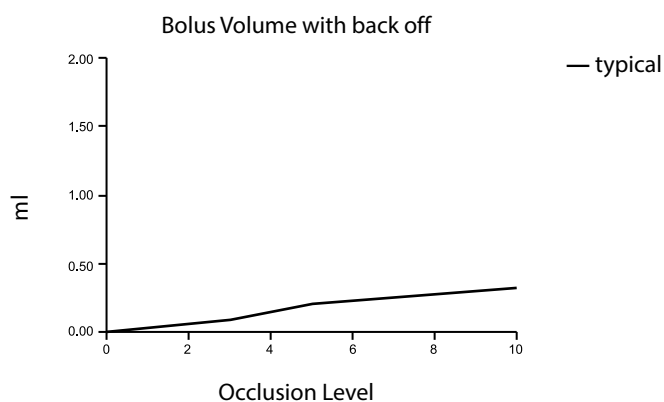
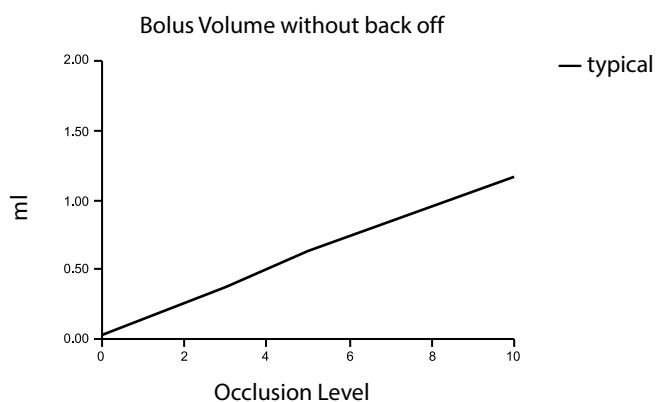
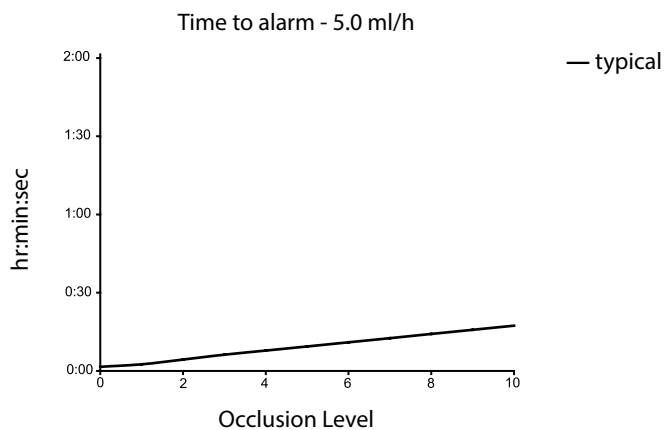
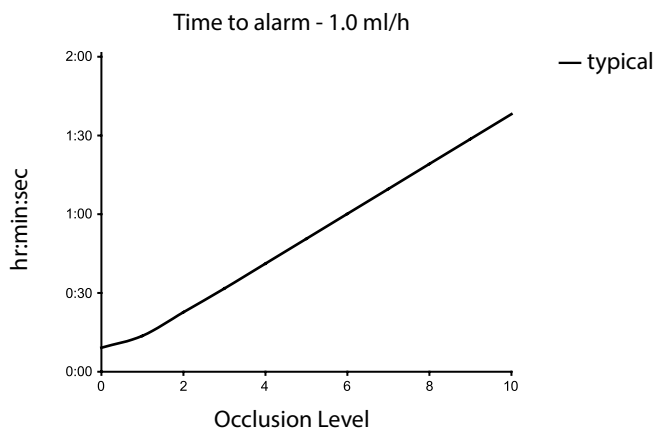

Tests at low alarm levels may alarm immediately - the force at these levels is commonly less than the friction in the syringe (with no additional fluid pressure). The result is that the pressure relating to the low forces will be less than the nominal quoted occlusion pressure.

Bolus volume following occlusion will be minimised by the back off feature if enabled. The back off will reduce the line pressure by removing the volume stored in the occluded line and deduct this volume from the volume infused. Back off will terminate if the pressure reaches the level recorded by the pump when the infusion was last started, or a maximum back off volume has been withdrawn from the extension set. It will also terminate if the volume infused reaches 0.0ml, or a VTBI reaches the value at which it was set.

IrDA, RS232 and Nurse call Specification

IrDA / RS232 / Nurse call Feature

The IrDA or RS232 / Nurse call is a feature on the pump that allows connection to a PC or another Alaris Syringe Pump. This allows data to be transferred between the pump and a PC or another Alaris Syringe Pump, (e.g. data sets to be uploaded to the pump, Event Reports to be downloaded from the pump and the pump to be monitored remotely via a suitable central monitoring or computer system).



The nurse call interface provides a remote backup to the internal audible alarm. It should not be relied upon to replace monitoring of the internal alarm.

Refer to the Technical Service Manual for further information regarding the RS232 interface. Since it is possible to control the syringe pump using the RS232 interface at some distance from the pump and hence remote from the patient, responsibility for the control of the pump is vested in the software run on the computer control system.

The assessment for the suitability of any software used in the clinical environment to control or receive data from the pump lies with the user of the equipment. This software should include detection of the disconnection or other failure of the RS232 cable. The protocol is detailed in the Alaris Syringe Pump Communications Protocol and is for general information only.

Any connected analogue and digital components are required to meet IEC/EN60950 for data processing and IEC/EN60601 for medical devices. Anyone connecting additional devices to the signal input or output is a system configurator and responsible for meeting the requirements of the system standard IEC/EN60601-1-1.

IrDA

Baud Rate	115.2 kBaud
Start Bits	1 Start Bit
Data Bits	8 Data Bits
Parity	No Parity
Stop Bits	1 stop bit

RS232 / Nurse call Connection Data

RS232 / Nurse call Specification -

Connector	D Type - 9 Pin	
TXD/RXD	EIA RS232-C Standard	
TXD Output Voltage Range	Minimum: -5V (mark), +5V (space)	
	Typical: -7V (mark), +7V (space) with 3kΩ load to ground	
RXD Input Voltage Range	-30V - +30V max.	
RXD Input Thresholds	Low: 0.6V minimum	
	High: 3.0V maximum	
RXD Input Resistance	3kΩ minimum	
Enable	Active, Low:-7V to -12V	- powers up the isolated RS232 circuitry
	Active, High:+7V to +12V,	
	Inactive: Floating/open circuit, allows isolated RS232 circuitry to power down.	
Isolation Socket/Pump	1.5kV (dc, or ac peak)	
Baud Rate	115.2 kBaud	
Start Bits	1 Start Bit	
Data Bits	8 Data Bits	
Parity	No Parity	
Stop Bits	1 stop bit	
Nurse Call Relay Contacts	Pins 1, 8 + 9, 30V dc, 1A rating	

Typical Connection Data -

1. Nurse call (Relay) Normally Closed (NC C)
2. Transmit Data (TXD) Output
3. Received Data (RXD) Input
4. Power Input (DSR)
5. Ground (GND)
6. Not used
7. Power Input (CTS)
8. Nurse call (Relay) Normally open (NC O)
9. Nurse call (Relay) Common (NC COM)

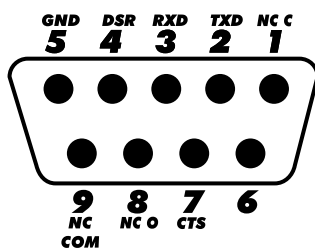

Trumpet Curves and Start-up Curves

In this pump, as with all infusion systems, the action of the pumping mechanism and variations in individual syringes cause short-term fluctuations in rate accuracy.

The following curves show typical performance of the system in two ways: 1) the delay in onset of fluid flow when infusion commences (start-up curves), and 2) the accuracy of fluid delivery over various time periods is measured (trumpet curves).

The start-up curves represent continuous flow versus operating time from the start of the infusion. They exhibit the delay in onset of delivery due to mechanical compliance and provide a visual representation of uniformity. Trumpet curves are derived from the second hour of this data. Tests performed per *EN/IEC60601-2-24:1998 standard*.

Trumpet curves are named for their characteristic shape. They display discrete data averaged over particular time periods or *observation windows*, not continuous data versus operating time. Over long observation windows, short term fluctuations have little effect on accuracy as represented by the flat part of the curve. As the observation window is reduced, short term fluctuations have greater effects as represented by the *mouth* of the trumpet.

Knowledge of system accuracy over various observation windows may be of interest when certain drugs are being administered. Short term fluctuations in rate accuracy may have clinical impact depending on the half-life of the drug being infused, therefore the clinical effect cannot be determined from the trumpet curves alone.



Start-up and trumpet curves may not be indicative of operation under negative pressure. Differences in factors such as size and plunger force in recognised syringes produced by other manufacturers can cause variations in accuracy and trumpet curves as compared to those represented. Additional curves for recognised syringes are available upon written request. For applications where flow uniformity is a concern, rates of 1.0ml/h or above are recommended.

Alaris CC Syringe Pump and Alaris CC Guardrails Syringe Pump

Start-up Trend. BD Plastipak 5ml @ 0.1ml/h

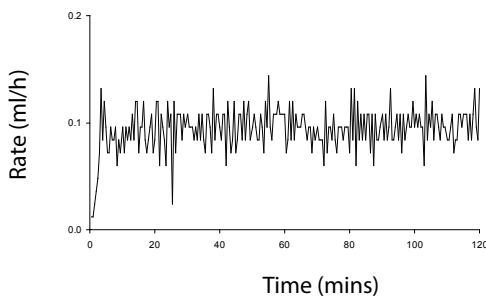

Trumpet Curve. BD Plastipak 5ml @ 0.1ml/h

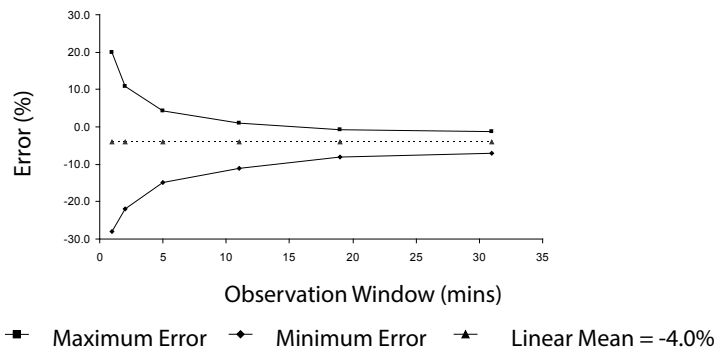

Start-up Trend. BD Plastipak 50 ml @ 1.0 ml/h

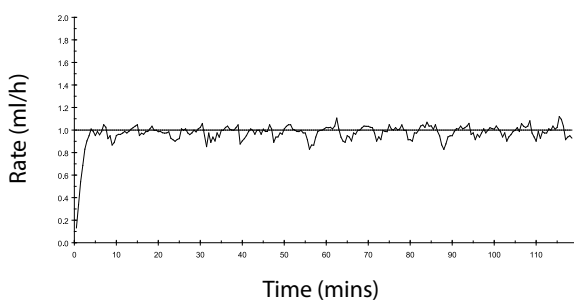

Trumpet Curve. BD Plastipak 50 ml @ 1.0 ml/h

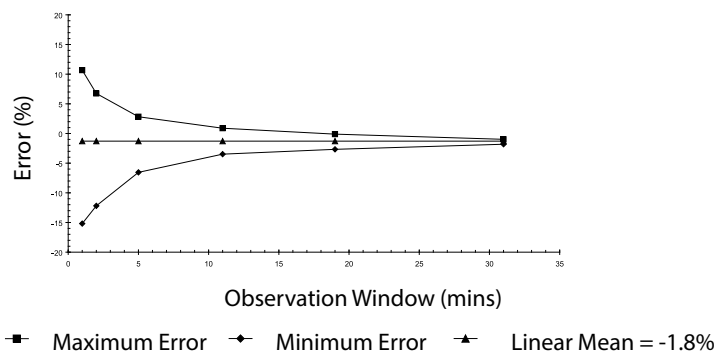

Start-up Trend. BD Plastipak 50 ml @ 5.0 ml/h

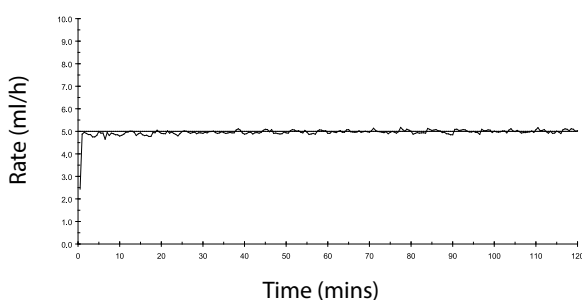

Trumpet Curve. BD Plastipak 50 ml @ 5.0 ml/h

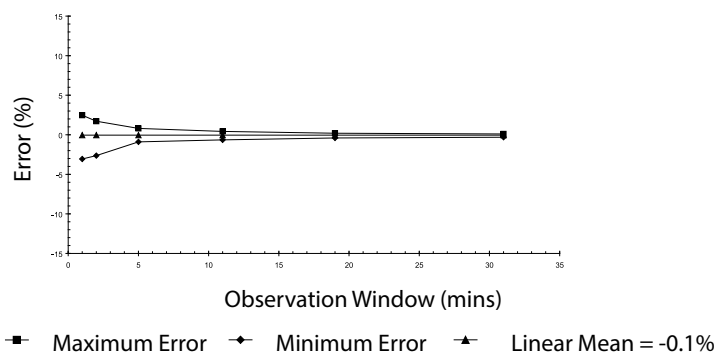

Alaris GH Syringe Pump and Alaris GH Guardrails Syringe Pump

Start-up Trend. BD Plastipak 5ml @ 0.1ml/h

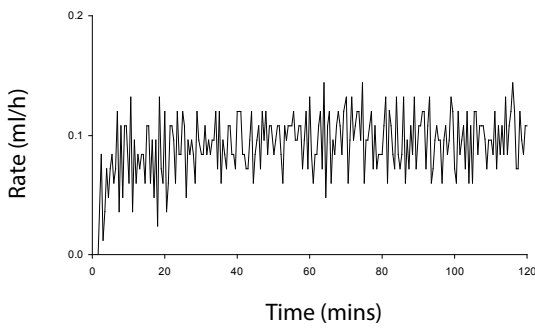

Trumpet Curve. BD Plastipak 5ml @ 0.1ml/h

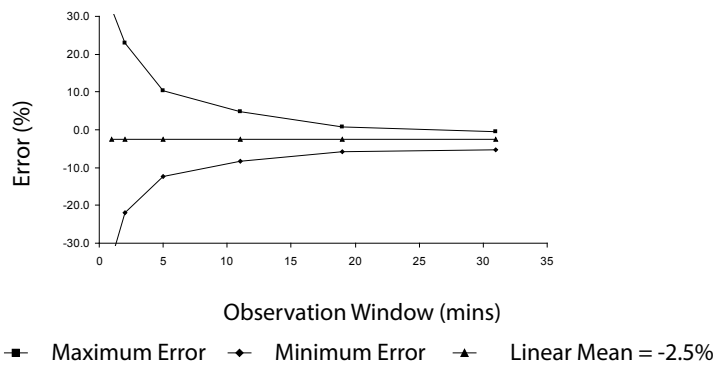

Start-up Trend. BD Plastipak 50 ml @ 1.0 ml/h

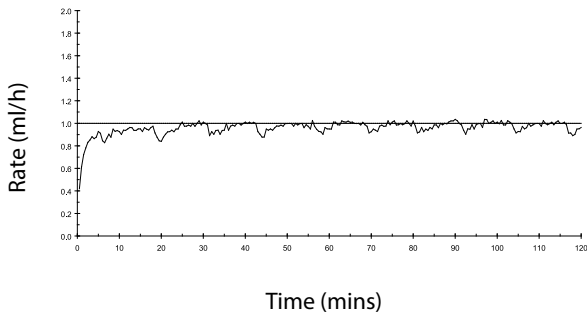

Trumpet Curve. BD Plastipak 50 ml @ 1.0 ml/h

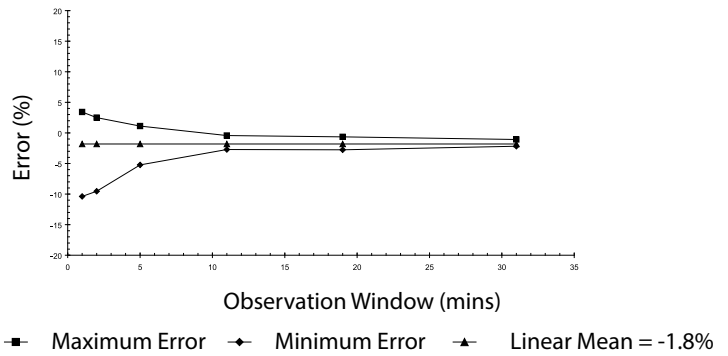

Start-up Trend. BD Plastipak 50 ml @ 5.0 ml/h

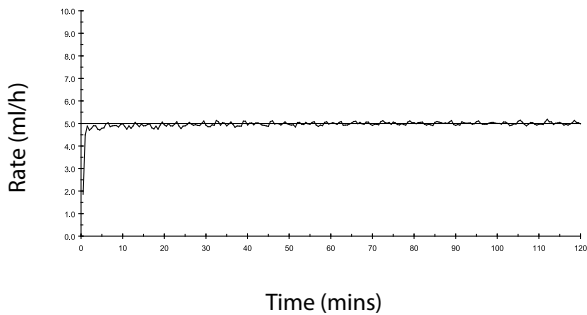

Trumpet Curve. BD Plastipak 50 ml @ 5.0 ml/h

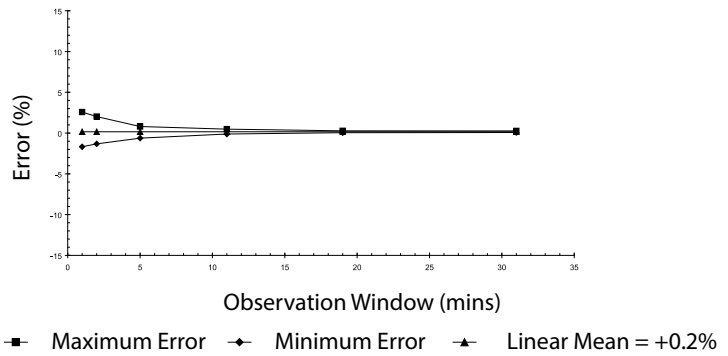

Products and Spare Parts

Spare Parts and Accessories

A comprehensive list of spare parts for this pump is included within the *Technical Service Manual*.

The *Technical Service Manual (1000SM00001)* is now available in electronic format on the World Wide Web at :-

www.carefusion.co.uk/alaris-technical/

A username and password are required to access our manuals. Please contact a local customer services representative to obtain login details.

Part Number	Description
1000SP01122	Internal Battery Pack
1001FAOPT91	AC Power Lead - UK
1001FAOPT92	AC Power Lead - European
1000SP01884	Lock box Accessory (Rate Un-Locked)
1000SP01885	Lock box Accessory (Rate Locked)

Alaris Editor Software

Part Number	Description
1000SP01462	Alaris Editor and Alaris Transfer Tool Software Kit
1000SP01463	Alaris Transfer Tool Software Kit

Service Contacts

For service contact your local Affiliate Office or Distributor.

AE	DE	HU	PT
CareFusion, PO Box 5527, Dubai, United Arab Emirates.	CareFusion, Tullastr. 8-12 69126 Heidelberg, Deutschland.	CareFusion, Döbrenthei tér 1, H-1013 Budapest, Magyarország.	CareFusion, Avda. São Miguel, 296 Atelier 14 2775-751 Carcavelos, Lisboa Portugal
Tel: (971) 4 28 22 842	Tel: (49) 6221 305 0	Tel: (36) 1 488 0232 Tel: (36) 1 488 0233	Tel: +351 219 152 593
Fax: (971) 4 28 22 914	Fax: (49) 6221 305 216	Fax: (36) 1 201 5987	Fax: +351 219 152 598
AU	DK	IT	SE
CareFusion, 3/167 Prospect Highway, PO Box 355 Seven Hills, NSW 2147, Australia.	CareFusion, Firskovvej 25 B, 2800 Lyngby, Danmark.	CareFusion, Via Ticino 4, 50019 Sesto Fiorentino, Firenze, Italia.	CareFusion, Marieviksgatan 25, Box 47204 117 43 Stockholm Sverige
Tel: (61) 1800 833 372	Tlf. (45)70 20 30 74	Tél: (39) 055 30 33 93 00	
Fax: (61) 1800 833 518	Fax: (45)70 20 30 98	Fax: (39) 055 34 00 24	
BE	ES	NL	US
CareFusion, Erembodegem-Dorp 86 B-9320 Erembodegem Belgium.	CareFusion, Edificio Veganova, Avenida de La Vega, nº1, Bloque 1 - Planta 1, 28108 Alcobendas, Madrid, España.	CareFusion, De Molen 8-10, 3994 DB Houten, Nederland.	CareFusion, 10020 Pacific Mesa Blvd., San Diego, CA 92121, USA.
Tel: +32 (0) 2 267 38 99	Tel: (34) 902 555 660	Tel: +31 (0)30 2289 711	Tel: (1) 800 854 7128
Fax: +32 (0) 2 267 99 21	Fax: (34) 902 555 661	Fax: +31 (0)30 2289 713	Fax: (1) 858 458 6179
CA	FR	NO	ZA
CareFusion, 235 Shields Court, Markham, Ontario L3R 8V2, Canada.	CareFusion, Parc d'affaire le Val Saint Quentin 2, rue René Caudron 78960 Voisins le Bretonneux France	CareFusion, Fjordveien 3 1363 HØVIK Norge.	CareFusion, Unit 2 Oude Molen Business Park, Oude Molen Road, Ndabeni, Cape Town 7405, South Africa.
Tel: (1) 905-752-3333	Tél: (33) 01 30 02 81 41	Tel: (47) 64 00 99 00	Tel: (27) (0) 860 597 572 Tel: (27) 21 510 7562
Fax: (1) 905-752-3343	Fax: (33) 01 30 02 81 31		Fax: (27) 21 5107567
CH	FI	NZ	
BD Switzerland, Terre-Bonne Business Park , Building A4 Route de Crassier 17, 1262 Eysins Switzerland	CareFusion, Kuortaneenkatu 2, 00510 Helsinki	CareFusion, 14B George Bourke Drive, Mt Wellington 1060, PO Box 14-518, Panmure 1741, Auckland, New Zealand	
Phone: ++41 21 556 3000	Tel: +358 207871 090	Tel: 09 270 2420 Freephone: 0508 422734	
Fax : ++41 21 556 3099		Fax: 09 270 6285	
CN	GB	PL	
康尔福盛（上海）商贸有限公司 地址：上海市浦东新区张杨路 500号24楼E. F. G. H单元	BD, 1030 Winnersh Triangle, Eskdal Road, Winnersh, RG41 5TS United Kingdom.	Becton Dickinson Polska Sp. z o.o. ul. Osmańska 14 02-823 Warszawa Polska.	
电话： +86-21-60369369 400 878 8885	Tel: (44) 0800 917 8776	Tel: (48) 22 377 11 00	
传真： +86-21-60369399		Fax: (48) 22 377 11 01	

Rev. Q

Page Intentionally Left Blank

CareFusion, Alaris, Guardrails, IVAC, SmartSite and the CareFusion logo are trademarks or registered trademarks of CareFusion Corporation or one of its affiliates. All rights reserved. All other trademarks are property of their respective owners.

©2018 CareFusion Corporation or one of its affiliates. All rights reserved.

This document contains proprietary information of CareFusion Corporation or one of its affiliates, and its receipt or possession does not convey any rights to reproduce its contents, or to manufacture or sell any product described. Reproduction, disclosure, or use other than for the intended purpose without specific written authorization of CareFusion Corporation or one of its affiliates is strictly forbidden.



CareFusion Switzerland 317 Sarl,
A-One Business Centre, Z.A Vers -La-
Pièce n° 10, CH-1180, Rolle



CareFusion UK 305 Ltd., The Crescent,
Jays Close, Basingstoke, Hampshire,
RG22 4BS, UK

1000DF00693 Issue 9