

BD Anesthesia Systems Catalogue

2002-2003



2771 Bristol Circle
Oakville, Ontario, L6H 6R5
Canada
www.bd.com

Customer Care: **1.800.268.5430**

BD offers a wide array of products to serve the needs of the Anesthesia Department. This list may help you to better serve those needs.

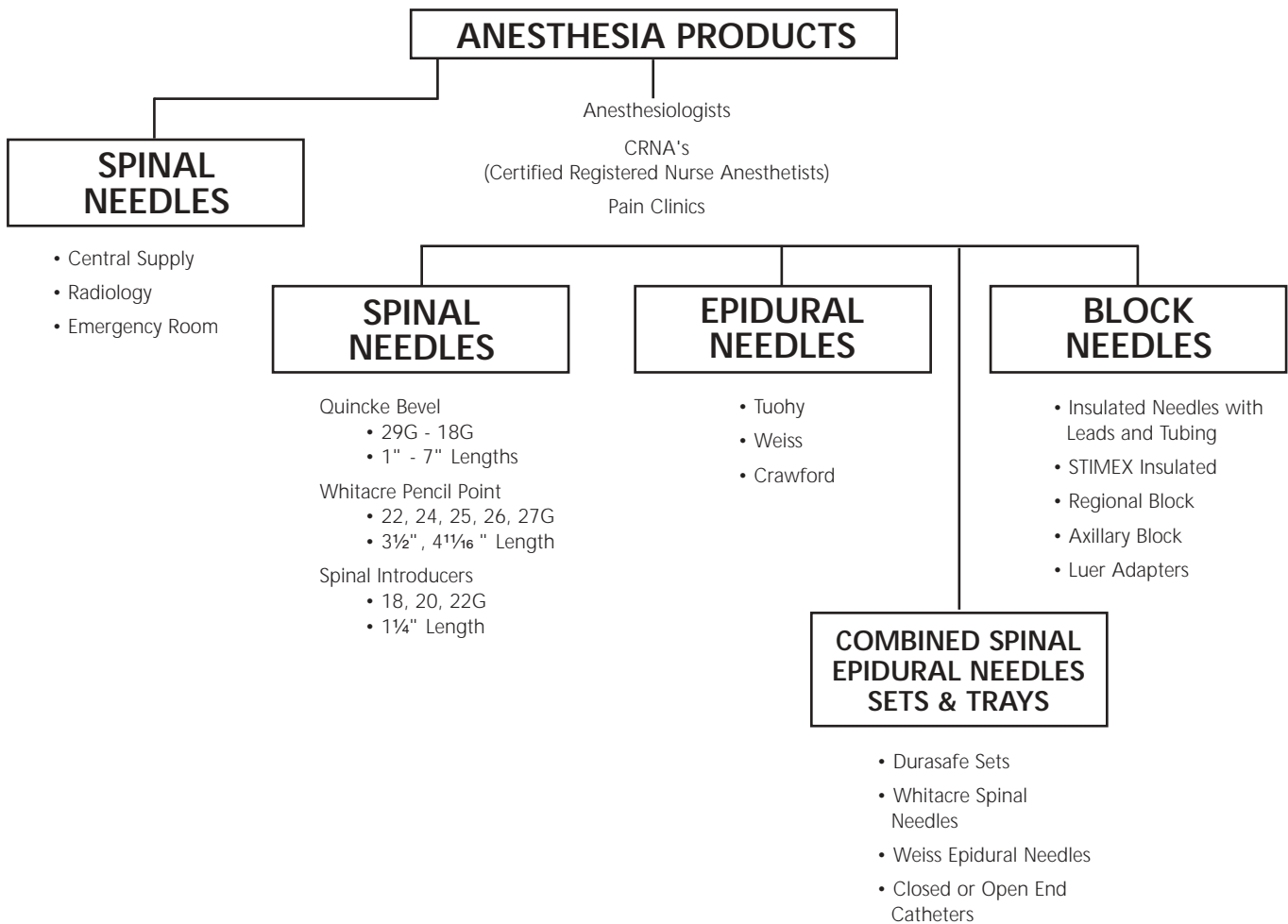

Product Description		
Reorder Number	Description	Pkg. Qty.

BD™ Spinal Needles, Quincke, Sterile, Single Use

405236	29G 3½ Clear	25/Box 100/Case
405081	27G 3½ Grey	
405164	26G 3½ Tan	25/Box
405170	25G 3 Blue	100/Case
405180	25G 3½ Blue	
400106	23G 3½ Turquoise	
405161	22G 1½ Black	
405074	22G 2½ Black	
405171	22G 3 Black	
405181	22G 3½ Black	
405162	20G 1½ Yellow	
405071	20G 2½ Yellow	
405172	20G 3 Yellow	
405182	20G 3½ Yellow	
405183	19G 3½ Brown	
405174	18G 3 Pink	
405184	18G 3½ Pink	
405070	18G 2½ Thin Wall Pink	

BD Spinal Introducers, Sterile, Single-Use

405072	22G 1¼ Clear (use with 27G and 29G Needles)	25/Box
405160	20G 1¼ Yellow (use with 25G and 27G Needles)	100/Case
405062	18G 1¼ Pink (use with 22G Needles and 24G Needles)	

BD Short Spinal Needle, Sterile, Single Use

405073	25G 1 Blue Neonatal Lumbar Puncture	10/Box 50/Case
405078	25G 2 Blue Neonatal Lumbar Puncture	25/Box 100/Case

BD Long Length Spinal Needles, Sterile, Single Use

405148	22G 5 Black	10/Box
405149	22G 7 Black	50/Case
405211	20G 6 Yellow	
408360	18G 6 Pink	
405234	25G 4 ¹¹ / ₁₆ Blue	
405235	27G 4 ¹¹ / ₁₆ High Flow Grey	

BD Whitacre High Flow Pencil Point Spinal Needles, Sterile, Single Use

405133	24G 3½" Purple	10/Box
405138	25G 3½" Blue	50/Case
405141	26G 3½" Tan	

BD Long Length Whitacre High Flow Pencil Point Spinal Needles, Sterile, Single Use

405135	24G 5" Purple	10/Box
405140	25G 5" Blue	50/Case
405143	26G 5" Tan	
405144	27G 5" Grey	

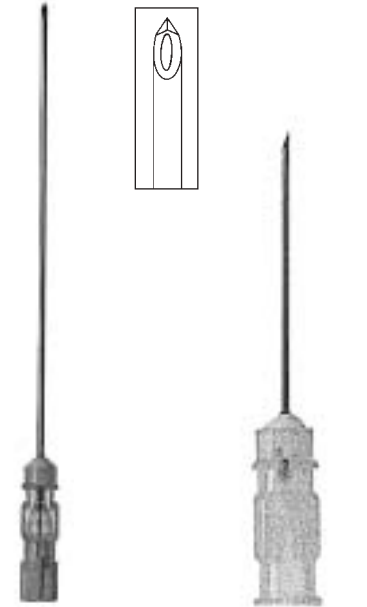

Spinal Needles,
Sterile, Single Use

Spinal Introducers,
Sterile, Single-Use



Whitacre
Pencil Point Spinal Needle

Product Description

Reorder Number	Description	Pkg. Qty.
----------------	-------------	-----------

BD™ Long Length Whitacre High Flow Pencil Point Spinal Needles, Sterile, Single Use (cont'd)

409443	27G 4 ¹ / ₁₆ " Grey	10/Box 50/Case
--------	---	-------------------

BD Whitacre Pencil Point Spinal Needles, Sterile, Single Use

405010	22G 3 ¹ / ₂ " Black	10/Box 50/Case
--------	---	-------------------

BD Short Whitacre Pencil Point Spinal Needles, Sterile, Single Use

405146	25G 1 ¹ / ₂ " Blue	10/Box 50/Case
--------	--	-------------------

BD Long Length Whitacre Pencil Point Spinal Needles, Sterile, Single Use

409442	25G 4 ¹ / ₁₆ " Blue	10/Box 50/Case
--------	---	-------------------

BD Perisafe™ Nylon Epidural Catheters with Connector, Sterile, Single Use

400507	20G x 36" Closed End, Three Hole with Guide For use with 18G x 3 ¹ / ₂ " Needle	10/Box 50/Case
400495	20G x 36" Closed End, Three Hole with Guide For use with 18G x 2" Needle	

BD™ Epidural Anesthesia Needles, Sterile, Single Use

Tuohy, No Wings, Modified Tuohy Point		
405092	17G 3 ¹ / ₂ " Thin-Wall	10/Box
405018	18G 3 ¹ / ₂ " Thin-Wall	50/Case
405028	20G 3 ¹ / ₂ " Thin-Wall	
Weiss, Fixed Wings, Modified Tuohy Point		
405191	17G 3 ¹ / ₂ " Thin-Wall	50/Case
Crawford Point		
408272	18G 3 ¹ / ₂ "	10/Box



Whitacre Pencil Point



Tuohy Weiss

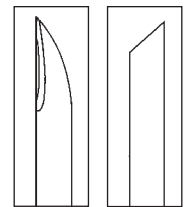

Modified Tuohy Schliff Crawford



Tactile Tuohy Point

Product Description		
Reorder Number	Description	Pkg. Qty.

BD Long Length Epidural Anesthesia Needles, Sterile, Single Use

	Weiss, Fixed Wing, Modified Tuohy Point	
405193	17G 5" Thin-Wall	10/Box 50/Case

BD Epilor™ Loss Of Resistance Syringe

405291	7cc LUER-LOK™ Plastic	10/Box
405292	7cc LUER-SLIP Plastic	50/Case

BD Perisafe™ Epidural Mini-Kits

400273	18G 3½" Weiss Epidural Needle 20G 36" Polyamide Catheter, Closed End, Three Hole with Guide 1-Catheter Connector, 1-.22 Micron Filter 10cc EPILOR Loss Of Resistance Syringe	
--------	---	--

BD Durasafe™ Combined Spinal/Epidural Procedure Sets with Whitacre Pencil Point Spinal Needle and Variable Extension Adaptor

400607	27G High Flow Whitacre Spinal Needle with Variable Extension Adaptor 18G Weiss Epidural Needle	10/Box 50/Case
400608	25G Whitacre Spinal Needle with Variable Extension Adaptor 17G Weiss Epidural Needle	
405139	25G 4¼" High Flow Whitacre Spinal Needle 17G 3½" Weiss Epidural Needle	10/Box 50/Case
405452	27G 4¼" Whitacre Spinal 18G 3½" Weiss Epidural Needle	10/Box 50/Case

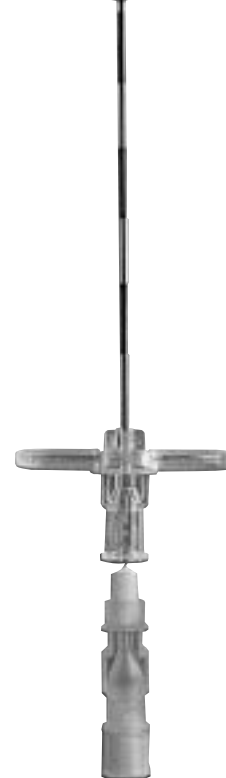
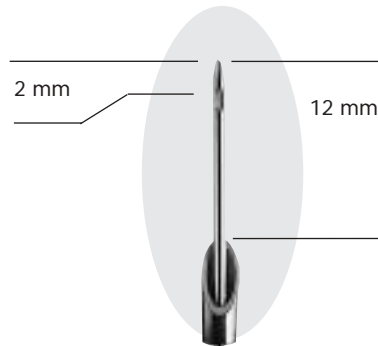

Durasafe
Combined Spinal Epidural Set



Epilor Syringe

Product Description		
Reorder Number	Description	Pkg. Qty.

BD™ Peripheral Block Needles, Sterile, Single Use

Regional Block Needle, Security Bead, Block Bevel		
408348	22G 1½"	10/Box 50/Case
BD STIMEX™ Insulated Needle, Teflon-Coated, Block Bevel		
404204	22G 2⅞"	10/Box
404201	22G 1½"	50/Case
404246	22G 4¼"	
Axillary Block Needles, Block Bevel		
409440	22G 1"	10/Box
409441	25G 1"	50/Case
Retrolubar		
401586	25G TW 1½"	10/Box 50/Case



Insulated Needle

BD Pudendal/Local Block Anesthesia Tray

402601	Pudendal/Local Block Tray with 10cc control syringe	20/Case
--------	---	---------

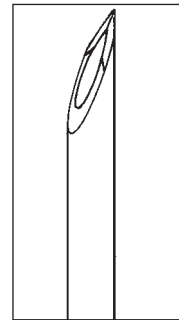

Regional Block Needle
Sterile, Single-Use

Product Description		
Reorder Number	Description	Pkg. Qty.

BD LongDwel™ Thin-Wall Catheter TEFLON Non-Sterile, with Metal Hub, Single Use

406723	01-0050 18G 8 Inner Needle 19G	
--------	--------------------------------	--

BD Catheter Introducer

406999	Sterile, Single Use	100/Box 2400/Case
--------	---------------------	----------------------

BD Suprapubic Catheter, Sterile, Single Use

408289	BONANNO Catheter Tray: 1-14G 11" TEFLON Catheter 1-18G Puncture Needle, 1-Adapter Clamp	6/Case
--------	--	--------

BD Whitacre Spinal Needle

511336	W462LNR 22G 3½	1/Box
--------	----------------	-------

BD Thin-Wall, Spinal with Fitted Stylet

511293	T462LNR 18G 6	1/Box
511310	T462LNR 14G 2	

BD Local Anesthesia SECURITY Bead Needle

511362	45LNR 22G 2	12/Box
511359	45LNR 22G 4	
511369	45LNR 20G 4	
511364	45LNR 20G 6	1/Box

BD Epidural Anesthesia Needles

511219	T466LNRH 17G 3 Tuohy Thin-Wall	1/Box
511284	T466LNRH 18G 3 Tuohy Thin-Wall	
511285	T466LNRH 17G 7 Tuohy Thin-Wall	1/Box

BD Pudendal and Parasympathetic Block Needles

511318	462LNRS 19G 5 Sympathetic Nerve Needle	1/Box
511317	462LNRS 20G 5 Sympathetic Nerve Needle	
511320	462LNRS 18G 6 Sympathetic Nerve Needle	
511319	462Inrs 20G 6 Parasympathetic Nerve Needle	



Longwel Thin-Wall Catheter



Local Anesthesia Security Bead Needle

Product Description		
Reorder Number	Description	Pkg. Qty.

BD™ Retrobulbar Anesthesia

511583	01-0001 23G 1% Atkinson	1/Box
--------	-------------------------	-------

BD Yale™ Spinal Reusable, Quincke

511114	462LNR 18G 3½
511142	462LNR 19G 3½
511139	462LNR 20G 3½
511140	462LNR 20G 4
511120	462LNR 22G 2
511136	462LNR 22G 3½



Yale Spinal Reusable, Quincke

BD Radiology and Biopsy Products

2002-2003

BD offers a wide array of needles for biopsy procedures.

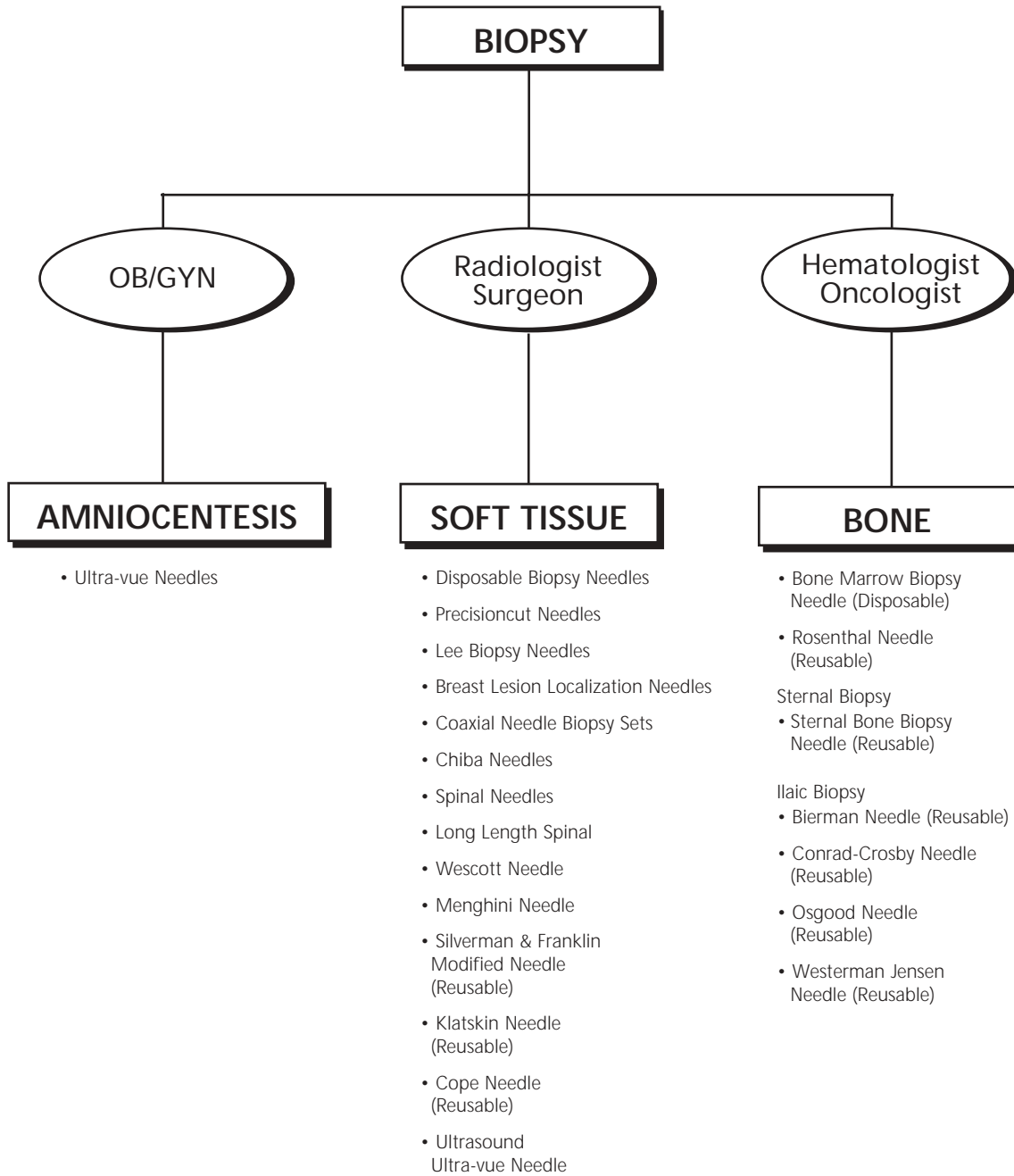

Product Description		
Reorder Number	Description	Pkg. Qty.

BD™ Angiography Needles For Seldinger Technique

Potts-Cournand Needle, Thin-Wall with Obturator and Cannula Extender		
408270	18G 2 ³ / ₄ for .032"- .038" Guide Wire	10/Box 50/Case
Arterial Needle Outer Blunt Cannula		
408273	18G 2 ³ / ₄ for .032"- .038" Guide Wire	10/Box
Amplatz Needle, Teflon Catheter Over Inner Needle with Fitted Stylet Sterile Single Use		
408275	18G 2 ¹ / ₂ for .032"- .038" Guide Wire	
Single Wall Puncture (M/P) Procedure Needle		
408295	18G 2 ³ / ₄ , One part needle with wings for .032"- .038" Guide Wire	10/Box 50/Case
408300	18G 2 ³ / ₄ , One part needle for .032"- .038" Guide Wire	

BD™ Myelogram Trays

Myelography Needles, Sterile Single Use		
408276	Cuatico 18G x 3 ¹ / ₂ " Blunt Aspiration Cannula - 9 Hole	10/Box 50/Case

UTW (Ultra Thin Wall)

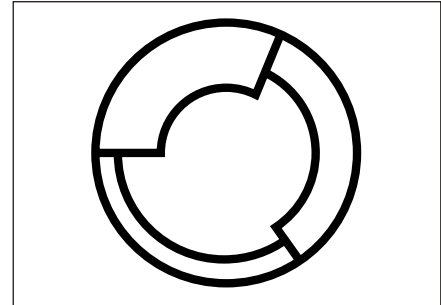

Arterial Needle
Outer Blunt Cannula

M/P Procedure Needle
One part needle with wings

Product Description

Reorder Number	Description	Pkg. Qty.
----------------	-------------	-----------

BD™ Arthrogram Trays

408501 Arthrogram Tray, Sterile Single Use

Tray consists of:	1 - 30 cc. Luer-Lok Syringe	1 - 10" Connecting Tube
1 - 5 cc. Luer-Lok Syringe	2 - Absorbant Towels	1 - 25G x 5/8" Needle
1 - Absorbant Fenestrated Drape	1 - 18G x 1 1/2" Transfer Needle	1 - Adhesive Bandage
1 - 10 cc. Luer-Lok Syringe	1 - 2 oz. Medicine Cup	5 - 3" x 3" Gauze Pads
2 - Small Basins	1 - 20G x 1 1/2" Short Bevel Ndl	2 - Prep Sponges



BD Westcott™ Fine Needle Aspiration Biopsy

408265	22G 3 1/2	10/Box
408267	22G 7	50/Case
408262	20G 3 1/2	
408263	20G 5 1/2	
408264	20G 7	

**BD Chiba Fine Needle Aspiration Biopsy/
Transhepatic Cholangiography Needles**

408268	22G 6 Chiba Type, Thin-Wall	10/Box
408269	22G 8 Chiba Type, Thin-Wall	50/Case

BD Breast Lesion Localization Needles

409407	Precisionguide™ 20G 3 1/2 (8.9 cm) with Hook Wire	10/Box
409408	Precisionguide 20G 2 1/2 (6.4 cm) with Hook Wire	50/Case
409409	Precisionguide 20G 1 1/2 (3.8 cm) with Hook Wire	

**BD EchoGenic Procedure Needles for Use
With UltraSound**

400727	Ultra-vue 22G x 3 1/2 Spinal Type Point	10/Box
400730	Ultra-vue 20G x 3 1/2 Spinal Type Point	50/Case

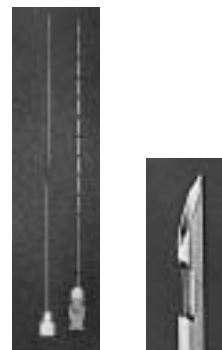

Westcott Fine Needle
Aspiration Biopsy

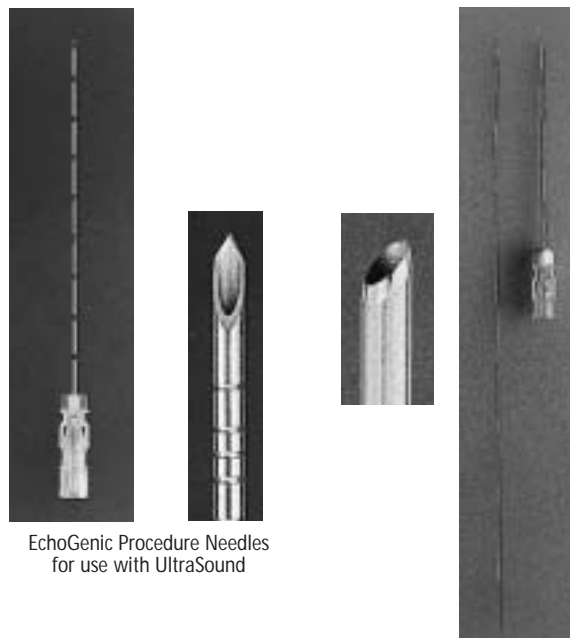

EchoGenic Procedure Needles
for use with UltraSound

Breast Lesion
Localization Needles

Product Description		
Reorder Number	Description	Pkg. Qty.

BD™ Liver, Kidney and Soft Tissue

511283	468LRT 13G 3¼ Aspirating Trocar	1/Box
511548	01-0008 14G 3% Silverman-B-D, Modified Franklin, Thin-Wall	1/Box
511547	01-0008 14G 4½ Silverman-B-D, Modified Franklin, Thin-Wall	1/Box
511282	469LNR 14G 3% Silverman	1/Box
511403	01-0109 16G 4 Klatskin, Thin-Wall	1/Box

BD Pleural Biopsy Needle

511421	01-0080 11G 3 Cope	1/Box
--------	--------------------	-------

BD Menghini Technique Aspirating, Thin-Wall

511491	01-0031 16G 2¾	1/Box
511485	01-0031 16G 4¾	1/Box

BD Menghini Biopsy Retaining Pin

511591	01-0112 16G	12/Box
--------	-------------	--------

BD Bone Marrow, Aspiration and Transfusion

511346	460LNR 16G 1⅝ Rosenthal	1/Box
511420	01-0081 10G 3 Large Silverman	1/Box
511348	458LNR 18G 1 Osgood	1/Box
511349	458LNR 16G 1⅝ Osgood	1/Box
511573	01-0004 10G 4¼ Westerman-Jensen	1/Box



Liver, Kidney and Soft Tissue

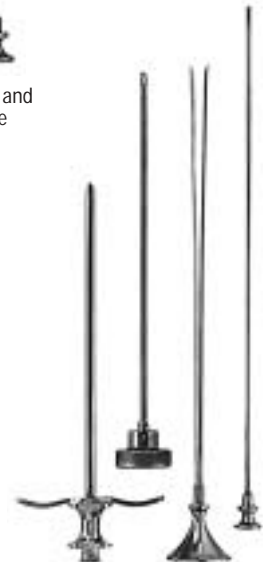

Bone Marrow, Aspiration and Transfusion, Westerman-Jensen

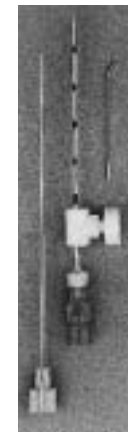

Menghini Biopsy Needles



Rosenthal

Osgood

Product Description

Reorder Number	Description	Pkg. Qty.
----------------	-------------	-----------

BD™ Needle Tubing Adapter, Sterile, Single Use

408205	15G ½ .066" I.D.-.071" I.D.	25/Box
408206	16G ½ .058" I.D.-.064" I.D.	100/Case
408208	18G ½ .042" I.D.-.049" I.D.	
408210	20G ½ .030" I.D.-.035" I.D.	
408213	23G ½ .020" I.D.-.025" I.D.	
408214	24G ½ .018" I.D.-.022" I.D.	

BD Catheter Adapter, Sterile, Single Use

403250	Catheter Adapter	100/Box 1000/Case
--------	------------------	----------------------

BD Adapters, Sterile

Luer-Lok Adapter Sterile, Single Use		
408299	LL/MLL Adapter Female to Male	50/Box 500/Case
Luer-Lok Caps, Sterile, Single Use		
408530	S/D Male L/L Cap Male Connection	50/Case
408531	S/D Female L/L Cap Female Connection	

BD Miscellaneous Adapters

408540	Male Cap Luer-Lok Non-Sterile	1000/Case
408541	Female Cap Luer-Lok Non-Sterile	

BD .154" I.D. Plastic, 1/8" I.D. Rubber Tubing

513096	H 468L Male Luer-Lok Adapter to Hose End	1/Box
--------	--	-------



Needle Tubing Adapter,
Sterile, Single Use



Catheter Adapter,
Sterile

Adapters, Sterile



408299



408531



408530